



**RENAULT**  
Passion for life

Renault Store - Technical specifications

# Façade markings



# Contents

---

## **General requirements**

General technical requirements	4
--------------------------------	---

---

## **General remarks**

Overview	12
Colours and materials	13

---

## **Technical principles**

General presentation	15
Drawings of main façade markings v1	16
Drawings of main façade markings v2	22
Correspondence between diamonds and façade heights	28
Fabrication principle for lettering	31
Schematic exploded view	32
Lighting	33

1

# Technical requirements

# General technical requirements

## 1.1 Preamble

RENAULT expects all those involved in the "Renault Store" programme to meet their obligations in terms of results as per the requirements of the Technical Specifications. The general rules and specificities set out below are to be considered as the minimum necessary that has to be done to achieve the expected result.

## 1.2. Safety of persons and property

The supplier shall be able to provide proof that it has analysed the risks related to the services it is to provide and that its personnel and any sub-contractors have undergone sufficient training. Strict compliance with legislation in terms of safety and protection of workers is required.

## 1.3. Respect for the environment

Materials and methods which make it possible to reduce harm to the environment shall be used wherever possible (recyclable materials, energy-saving technologies, toxicity of materials and products used, etc.).

The supplier shall be able to provide proof that it has the various administrative permits (operating permit, environmental permit) necessary to manufacture the various items of equipment and that it complies with the operating conditions required by the legislation in force or by the specific operating conditions in the countries concerned.

A global approach such as the ISO 14001 standard is recommended. e.

## 1.4. Quality

The supplier shall be able to provide proof that it works in accordance with ISO 9000 quality assurance standards, formal certification being particularly recommended in this regard. The signwriter shall attach a specific Quality Plan to its offer to assure RENAULT of its capacity to supply finished products and spare parts that are compliant with the contractual requirements, within the set time periods. It shall request its sub-contractors to do likewise.

The procedures applied must make it possible to:

- Be sure that the parts and products purchased, manufactured and supplied shall neither be used nor delivered before they have been checked and be recognized as compliant.
- Procedures shall be set out for identifying causes of non-compliance, which make it possible to provide sustainable solutions that can be applied more widely to resolve the non-compliance and prevent it reoccurring.

These operations shall be recorded in the appropriate documents and be approved by RENAULT prior to being applied more widely.

- Track changes in the quality of products and assembly and removal services using inspection and audit indicators (incidents, complaints, etc. ).

This tracking shall result in preventive or corrective actions; they shall be approved by RENAULT before being applied.

## General technical requirements

### 1.5. Compliance of messages and colours

Visuals must comply with the official images contained in this document.

All shades have a 40% satin finish unless specified otherwise. Particular attention should be paid to complying with the colour code.

Compliance with the tolerances for the L.a.b. is required.

### 2.1. General technical standards

The reference base to be followed for design and manufacturing shall, at the very least, be that required by Eurocode standards.

The regulations relating to the dimensioning of structures in force in each of the countries concerned shall be complied with taking climatic conditions into account.

The following obligations in terms of results must be met:

- Supported under their own weight, the equipment must appear perfectly horizontal and vertical.
- The parallel alignment of separate elements must be observed.
- Under normal wind conditions (Cf. NV65 and NF EN1991-1-4 (Eurocode 1)), the permissible bend between the fastening and the point most distant from the fastening (dimension "d") shall not exceed  $d/100$ .

#### 2.1.1. CLIMATIC CONDITIONS

Wind loads to be considered for the design of structures shall be taken from the Eurocode 1 rules (EN 1991-1-3): zones 4 (28 m/s), roughness IIIb, force coefficient equal to 1.80. Any structure situated in an unfavorable geographical area with regard to this load case shall be subject to a special design basis in order to meet the applicable standards.

#### 2.1.2. DESIGN RULES

##### 2.1.2.1 Aluminium structures

Design rules for aluminium structures - most recent edition of DTU rules (currently, July 1976).

Applicable standard for the execution of structures: NF EN 1090-2 and Eurocode 9.

##### 2.1.2.2 Steel structures

Design rules for steel structures CM 66 » - most recent edition.

Applicable standard for the execution of structures: EN 1093 and Eurocode 3.

##### 2.1.2.3 Concrete blocks

Concrete blocks shall be of "weight" type with minimum reinforcement.

The concrete to be used shall have an ordinary Portland cement (OPC) content of 400 kg/m<sup>3</sup> (s' 28=300 bars - s28=25 bars).

## General technical requirements

### 2.1.2.4 Design calculations for plastic elements

Adapt the CM 66 rules using a safety coefficient of 2 for the stresses.

### 2.1.3. MATERIALS

#### 2.1.3.1 General remarks

The materials used shall all be first-choice materials suitable for their envisaged use and they shall be used in accordance with the rules of best industry practice for the profession and in compliance with the standards and regulations in force in France and in the Countries in which they are intended to be used.

The materials used shall not have any defect that is likely to compromise the durability of the structures. The equipment shall be easy to clean, maintain and service.

The materials shall be capable of withstanding harsh climatic conditions such as rain, snow, hail, condensation, dust and salt spray.

Operation must be guaranteed between - 20 and + 80 ° C.

#### 2.1.3.2 Steels

Steels shall be either "hot finished" as per NF EN 10210 or "cold finished" as per NF EN 10219-1 and 2. The quality of the steels shall be stated on the production drawings and it goes without saying that the mechanical properties of the different types of steels must be taken into account for stability calculations.

All elements shall be manufactured in a covered, sheltered location.

After machining, welding, drilling, notching, etc. the elements shall be prepared prior to anti-corrosion treatment: brushing of welds, careful deburring, cleaning, shot peening and sand blasting.

The anti-corrosion treatment shall be performed by hot galvanization of a minimum of 80 µm and shall provide fault-free protection for at least the period of the ten-year guarantee.

No machining may be carried out once the parts have undergone anti-corrosion treatment.

All fasteners and hardware (including hinges) shall be made of 18/10 stainless steel (NFE 25.033).

#### 2.1.3.3. Aluminium

The reference standard is NF EN 573-1. Parts used in a supporting structure shall be chosen from the "6000" series. For parts which are not used in a supporting structure, the "1000" series shall be acceptable.

The alloys are to be weldable.

The parts shall be carefully deburred and the welds shall be brushed before any protective treatment.

The visible parts of equipment shall be treated by the application of paintwork performed according to a "Qualicoat"-type procedure.

## General technical requirements

### 2.1.3.4. PMMA

The PMMA shall meet at least the following characteristics:

	Flat parts machined "cast" PMMA	Flat parts unmachined "extruded" PMMA
• Opal white (values for a test piece of 3mm thick)		
• Tensile strength	> 75 MPa	> 70 MPa
• Bending strength	> 130 MPa	> 120 MPa
• Bending modulus	> 3,250 MPa	> 3,000 MPa
• Unnotched CHARPY impact test strength	> 12 MPa	>10 MPa
• Expansion	< 1 mm / 1 m / 10°C	<1 mm / 1 m / 10°C
• Light transmittance	> 50 %	>33 %

The thermoformed panels shall be made of white, light diffusing, extruded PMMA in compliance with the sheet manufacturer's heating parameters.

Where parts made of PMMA are more than 100 cm high, they shall be hung from the top by an adhesive PMMA cleat.

The thickness of the sheets shall be calculated in compliance with the tensile strength standards set out above.

### 2.1.3.5. Polycarbonate

The polycarbonate sheet shall meet at least the following characteristics:

- Uncoloured appearance
- Density > 1.2 g/cm<sup>3</sup>
- Tensile strength: 60 Mpa
- Expansion < 0.7 mm / 1 m / 10°C
- Light transmittance > 90%

### 2.1.3.6. Expanded foam

These following characteristics must be met:

- Material 9010 white PVC
- Density > 50 g/cm<sup>3</sup>
- UV-stabilized: 14 MPa
- Shore hardness D > 75
- Expansion < 1 mm / 1 m / 10°C

### 2.1.3.7. Paint

Painted parts must have an even appearance across their entire surface.

Defects such as pores, fissures, grains of dust, runs or waves of paint shall not be tolerated.

## General technical requirements

Samples of painted rough parts shall be tested and accepted by RENAULT, after having undergone the following tests performed by a certified body:

- Colour based on a LAB test with a MINOLTA 508 D colorimeter with D65 illuminant and the observer at 10° and specular component included (the tolerances in the CIELAB colour space are L +/- 1, a +/-1.5, b +/- 1.5).
- Gloss at 40 °: based on a test according to NF T 30064 standard.
- Gloss at 60 °: based on a test according to NF T 30064 standard
- Adhesion: resistance to peeling based on grid test.  
Class 1, as per P UW 150 1. NF T 30038 standard
- Colourfastness:  
QUV as per NF T 30036 after 200 hours of exposure.

Samples of each of the elements shall be supplied, upon request, to RENAULT for inspection.

### 2.1.4. ELECTRICAL EQUIPMENT

Assemblies with electrical equipment shall comply with the essential safety requirements of the European Union. Within this framework, the supplier shall obtain a certificate (for each type of equipment) which must clearly state the compliance of the assemblies, and thus of the components, with:

- requirements relating to the safety and protection of users and all other persons (directive 73/23/EEC without any lower voltage threshold)
- requirements relating to electromagnetic compatibility (directive 89/336/EEC).

The rating plate on each item of equipment shall display the CE mark indicating compliance with these requirements.

The regulations relating to low-voltage signage in force in each of the countries concerned shall be complied with taking climatic conditions into account.

In addition, the following requirements shall be met:

Electrical equipment shall be compliant with the standards in force from the series NFC 15-100, NFC 20-010 and NFC 20-030, NFC 71, NFC 32 for France and the IEC 60364 international standard.

This concerns the following in particular:

- Category one electrical installations and low-voltage illuminated signage installations.
- The fire behaviour of electrical equipment and the degree of protection of enclosures,
- Flexible and rigid low-voltage cables.

In addition, the equipment shall comply regulations relating to the suppression of interference in inhabited areas and shall thus be delivered with interference suppression.



## General technical requirements

### 2.1.4.1 IP rating

All the electrical equipment shall have a protection rating of at least IP 44-D.

### 2.1.4.2 Protection against electric shock

All equipment shall be "class 1".

### 2.1.4.3 Fasteners

The converters shall be placed in areas not subject to standing water.

The cables and sheaths shall be fastened to structures at 50 cm intervals.

### 2.1.4.4 Cable routing

Every cable or sheath passing through a metal part shall be routed through a cable gland.

Connection boxes.

An IP 44 sealed plastic connection box shall be provided at the inlet to each assembly. This box shall be equipped with a 5-input connection pin for 4 mm wiring.

All the connection boxes shall have the markings P1+P2+P3+T+N.

### 2.1.4.5 LEDs

The white LEDs used shall have the following characteristics:

- Lifetime: 50,000 hours for a loss of initial luminous flux of 50 % at the end of the period
- 5 year guarantee for operation 10 hours per day with a maximum loss of luminous flux of 20 %
- Operating temperature of LEDs: between - 20° C and +50 °C.
- Minimum protection index: IP 67
- The LEDs used must comply with the following international standards: IEC 62504 TS Ed. 1, IEC 61231, IEC 62560 Ed 1, IEC 62031 LED module safety, IEC 61347-2-13 LED control gear.

### 2.1.4.6 Converters

The power supply converters for the LEDs shall have the following characteristics:

- Wide power supply voltage range (100 to 300 volts)
- Reversible protection against increase in temperature and overload
- Protection against short-circuits with automatic restart
- Minimum protection index: IP 67
- Operation compliant with: EN 55015, EN 61000-3-2, EN 61547, EN 61558-2-17

## General technical requirements

### 2.1.5. FASTENERS AND HARDWARE

All fasteners and hardware used shall be made of stainless steel (non-magnetizable).

Aluminium "pop" rivets are accepted as long as the steel rods are systematically removed.

For welding, the wires and electrodes are to be compliant with NF 81.830.

### 2.1.6. ANCHORING SYSTEMS AND FASTENINGS

The plinths for all equipments shall be completely removable without having to remove another element of the assembly. The plinths shall cover the attachment plates or fastenings. The attachment plates shall be easily accessible once the plinths have been removed.

For each of the assemblies which require a foundation block or fastening to a separate structure, the signwriter shall provide the elements necessary, as well as the conditions to be used to make design calculations for these elements (wind conditions and design calculation methods).

### 2.1.7. IDENTIFICATION PLATE

Each finished product shall be marked with a metal identification plate on the structure which shall show at least the following information:

- Name of the signwriter
- Product code and batch
- Month and year of manufacturing
- The CE Marking if it is illuminated.

### 2.1.8. STORAGE

The finished products shall be stored in a dry and well-ventilated location.

RENAULT inspectors shall be able to have access to them at any time.

## 2.2. Guarantees

The suppliers undertake to offer the guarantee conditions below for their products:

- 2 year guarantee on the installation against defects and faulty workmanship,
- 5 year guarantee on the electrical equipment including the LEDs and converters,
- 5 year guarantee on the adhesive elements,
- 5 year guarantee on digital printing (anti UV treatment),
- 5 year guarantee on workshop-lacquered sheet metal,
- 5 year guarantee on the chrome-plated diamonds,
- 7 year guarantee on sheet metal and profiles pre-lacquered by the aluminium manufacturer,
- 10 year guarantee on the internal structures,
- 10 year guarantee on the PMMA acrylic panels.

2

General remarks

## Overview

### Description

Façade markings include:

- the Renault signature,
- the Site name.



## Colours and materials

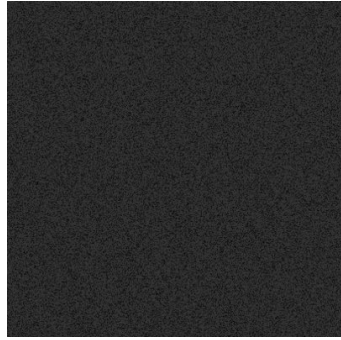

### **Metallic dark grey**

- Post-lacquered aluminium sheeting, 20/10 mm thick
- Satin finish with 40% gloss
- Metallic finish



### **Gloss chrome**

- Vacuum metallized light-diffusing polycarbonate with gloss varnish protection



### **Black équivalent RAL 9005**

- Satin or matt adhesive
- Non transmissive PMMA
- Satin finish with 40% gloss

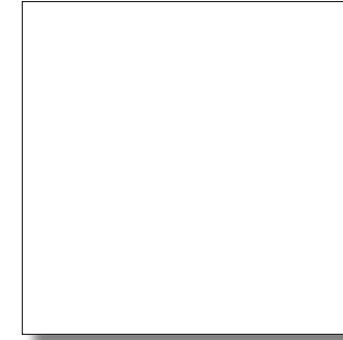

### **Pure white**

- Satin or matt adhesive
- Light diffusing PMMA Light transmittance 50%

3

# Technical principles

# General presentation

## Principle

The façade markings include:

- the Renault signature, made up of the diamond and the Renault word,
- the Site name.

These elements are always placed on the dark grey background of the woven-metal mesh in dealerships sites (Dealer Network R1).

Note that there is an economic alternative designed for secondary sites (Network R2).

Two layout drawings, defining the proportions between the diamond and the Renault word, are recommended:

- layout drawing v1, for façades of standard heights,
- layout drawing v2 for low façades (less than 1.5 m of frontage).

## Key

- 1 Renault signature (3D diamond and Renault word), with v1 layouts
- 2 Site name

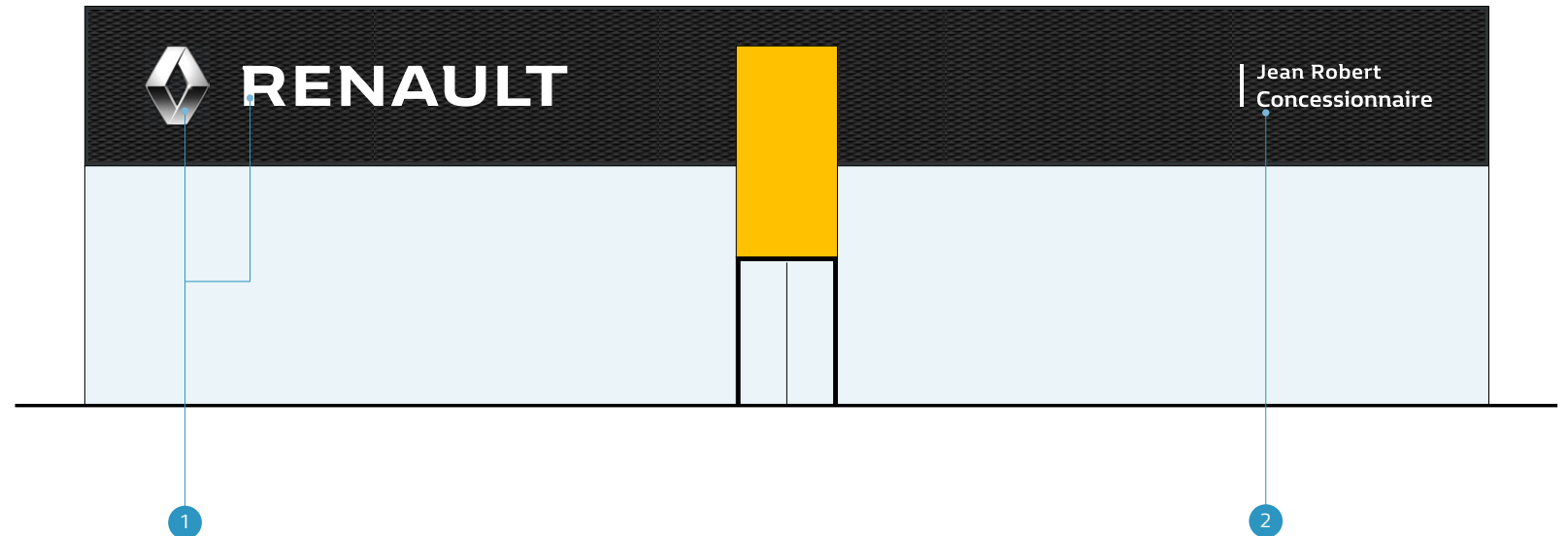

## Drawings of main façade markings v1

### Principle

This layout shows the proportions between the different components featuring on the main façade.

The height of the Renault word is calculated based on the letter "E".

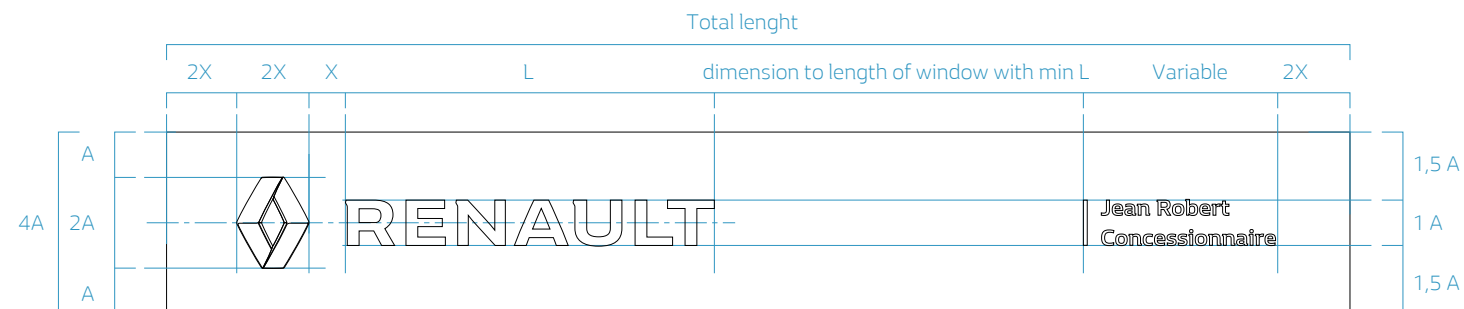

### Key

- 1 Dark grey background in woven-metal mesh
- 2 3D diamond, LED-backlit, with light-diffusing chrome finish
- 3 Renault word in backlit box letters, with white PMMA face, 30/10th mm thick PMMA edges matt black finish
- 4 Backlit vertical strip, made of white LED blocks, edges masked with matt black adhesive
- 5 Backlit Site name, made of white LED blocks, edges masked with matt black adhesive
- 6 "Dealer" lettering, backlit, made of white LED blocks, edges masked with matt black adhesive



Dimension	Diamond 860	Diamond 980	Diamond 1200	Diamond 1800
A	430	490	600	900
2A	860	980	1200	1800
4A	1720	1920	2400	3600
1,5A	645	735	900	1350
X	344	392	480	720
2X	688	784	960	1440
L	3497	3985	4879	7318
Ep	72	72	72	100



## Layout of Site name v1

### Principle

This layout shows the proportions between the different components of the Site name.

The height of the Site name is always equal to 33% of that of the Renault word.

NOTE: Dimension e1 represents the thickness of the lettering. Letters can be backlit by LED-blocks.

### Key

- 1 Backlit vertical strip, made of white LED blocks, edges masked with matt black adhesive
- 2 Site name, Renault Life bold typography, standard tracking, capitals on first letter of surnames and first names.
- 3 "Dealer" lettering, Renault Life regular typography, standard tracking.

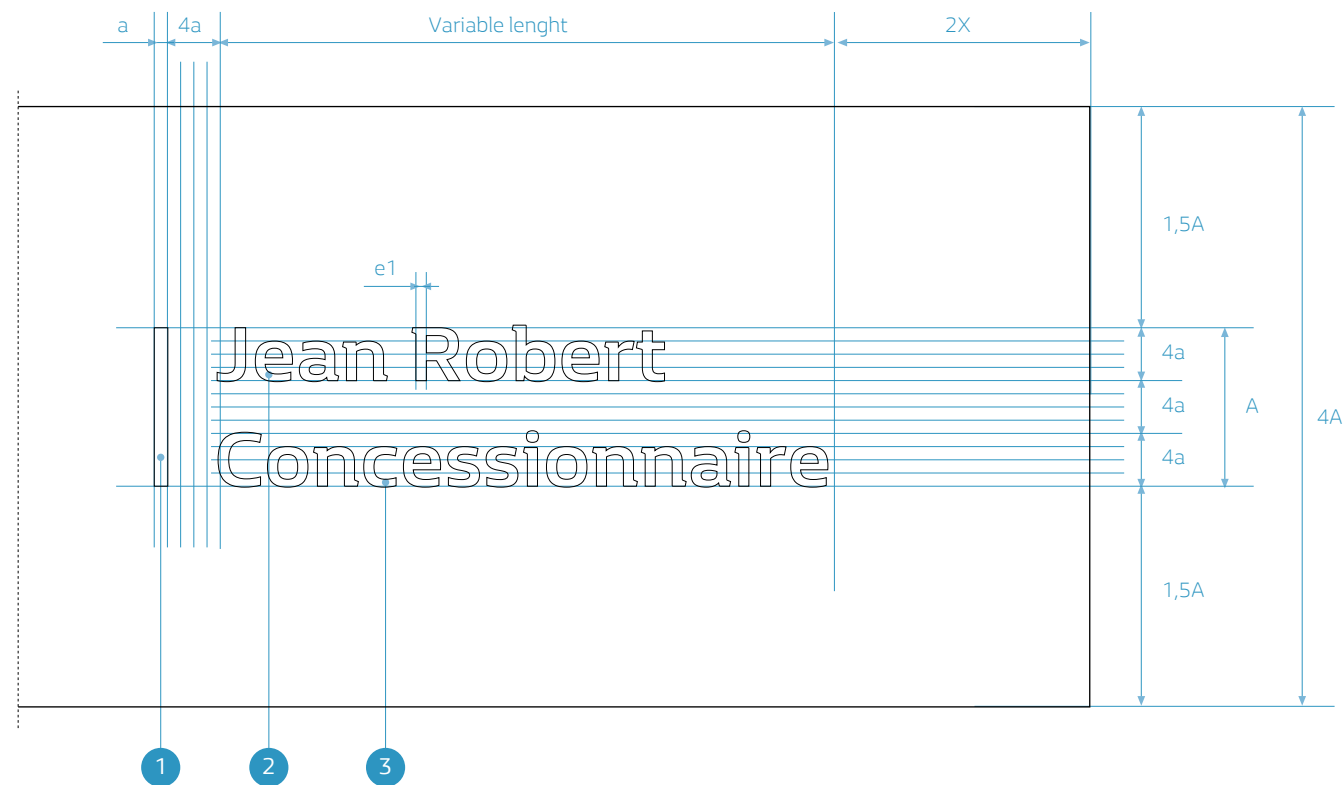

Dimension	Diamond 860	Diamond 980	Diamond 1200	Diamond 1800
4A	1720	1920	2400	3600
1,5A	645	735	900	1350
A	430	480	600	900
2X	344	392	480	720
a	35,8	40	50	75
4a	143,3	160	200	300
e1	32,5	36,2	45,3	68

## Drawings of secondary façade markings v1

### Principle

This layout gives a minimum dimension for the signature on a secondary façade.

The secondary façade does not display the Site name.

Dimension Lm represents the minimum length of the façade compatible with the use of this signature on a secondary façade.

The height of the Renault word is calculated based on the letter "E".

### Key

- 1 Dark grey background in woven-metal mesh
- 2 3D diamond, LED-backlit, with light-diffusing chrome finish
- 3 Renault word in backlit box letters, with white PMMA face, 30/10th mm thick PMMA edges matt black finish

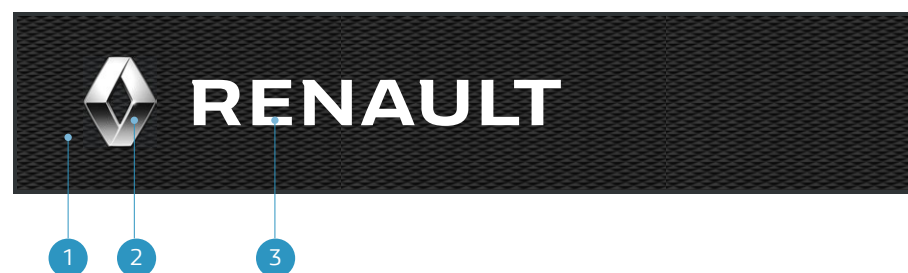
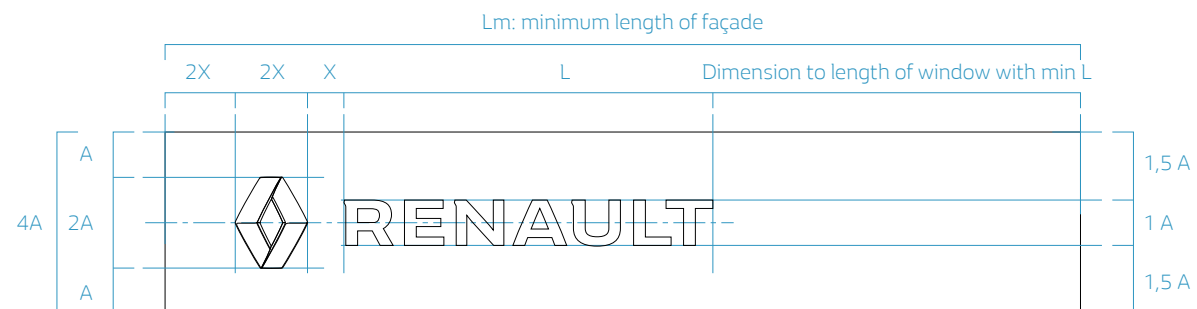

Dimension	Diamond 860	Diamond 980	Diamond 1200	Diamond 1800
A	430	490	600	900
2A	860	980	1200	1800
4A	1720	1920	2400	3600
1,5A	645	735	900	1350
X	344	392	480	720
2X	688	784	960	1440
L	3497	3985	4879	7318
Lm	8714	9930	12158	18236
Ep	72	72	72	100

## Drawings of blind façade markings v1

### Principle

This layout gives the standard dimensions of the signature on a highly visible blind façade (façade without the glazed sections of a showroom).

The height of the Renault word is calculated based on the letter "E".

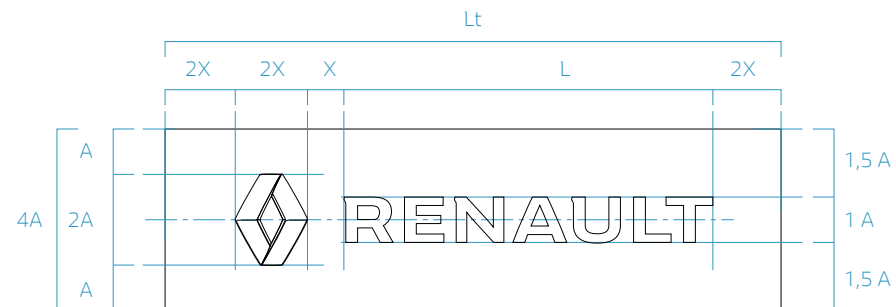

### Key

- 1 Dark grey background in woven-metal mesh
- 2 3D diamond, LED-backlit, with light-diffusing chrome finish
- 3 Renault word in backlit box letters, with white PMMA face, 30/10th mm thick PMMA edges matt black finish

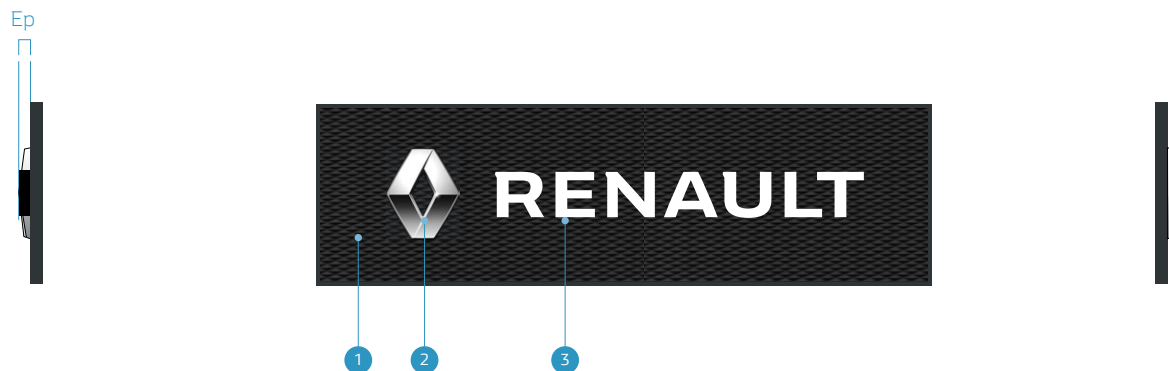

Dimension	Diamond 860	Diamond 980	Diamond 1200	Diamond 1800
A	430	490	600	900
2A	860	980	1200	1800
4A	1720	1920	2400	3600
1,5A	645	735	900	1350
X	344	392	480	720
2X	688	784	960	1440
L	3497	3985	4879	7318
LT	5905	6729	8239	12358
Ep	72	72	72	100

## Site name on a single line v1

### Principle

This layout shows the proportions between the Renault Signature and the Site name on a single line whose height is equal to 50% of that of the Renault word.

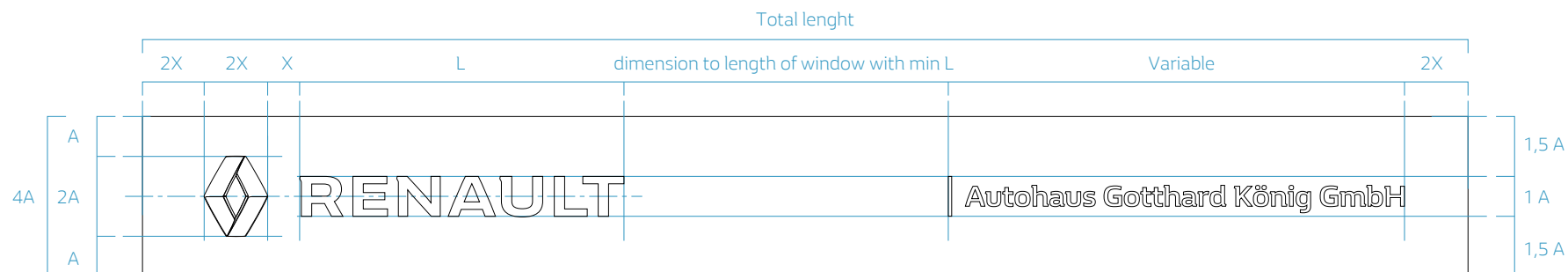

### Key

- 1 Dark grey background in woven-metal mesh
- 2 3D diamond, LED-backlit, with light-diffusing chrome finish
- 3 Renault word in backlit box letters, with white PMMA face, 30/10th mm thick PMMA edges matt black finish
- 4 Backlit vertical strip, made of white LED blocks, edges masked with matt black adhesive
- 5 Backlit Site name, made of white LED blocks, edges masked with matt black adhesive

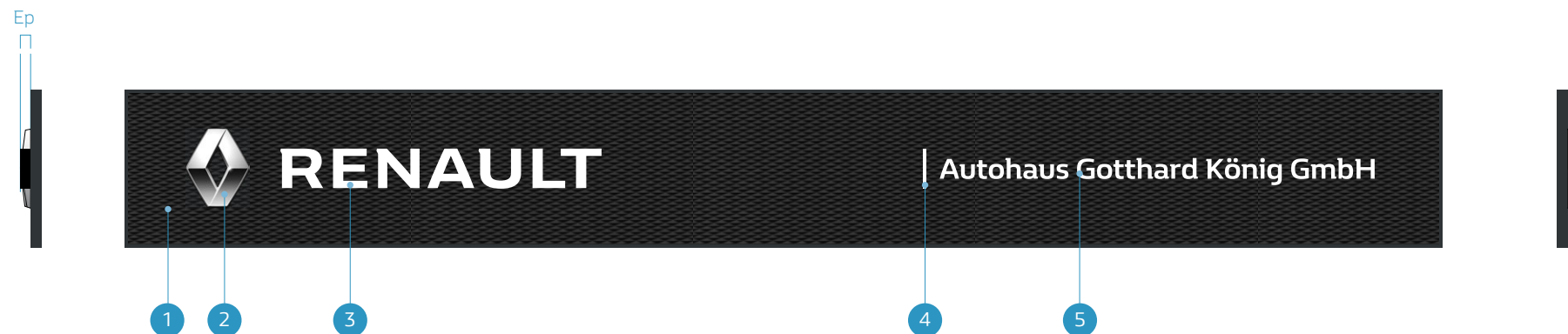

Dimension	Diamond 860	Diamond 980	Diamond 1200	Diamond 1800
A	430	490	600	900
2A	860	980	1200	1800
4A	1720	1920	2400	3600
1,5A	645	735	900	1350
X	344	392	480	720
2X	688	784	960	1440
L	3497	3985	4879	7318
Ep	72	72	72	100

## Layout of Site name on a single line v1

### Principle

This layout shows the proportions between the different components of the Site name on a single line.

The height of the Site name is always equal to 50% of that of the Renault word.

NOTE: Dimension e1 represents the thickness of the lettering. Letters can be backlit by LED-blocks.

### Key

- 1 Backlit vertical strip, made of white LED blocks, edges masked with matt black adhesive
- 2 Site name, Renault Life bold typography, standard tracking, capitals on first letter of surnames and first names.

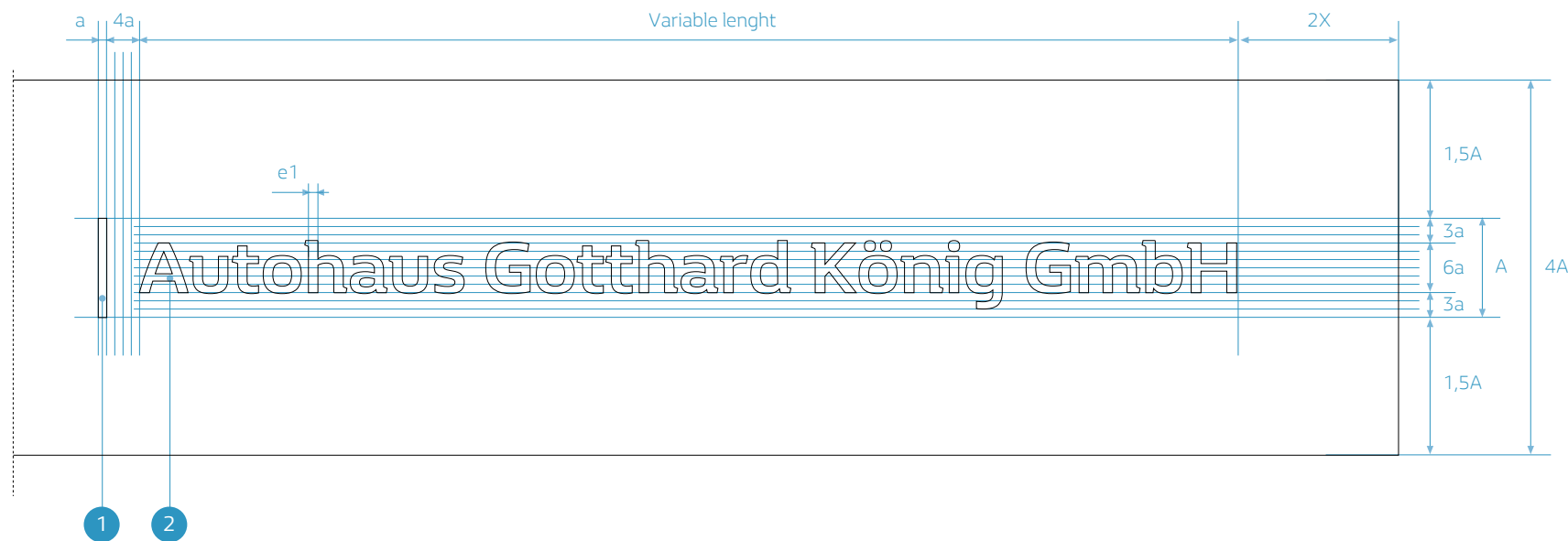

Cote	Diamond 860	Diamond 980	Diamond 1200	Diamond 1800
4A	1720	1920	2400	3600
1,5A	645	735	900	1350
A	430	480	600	900
2X	344	392	480	720
a	35,8	40	50	75
3a	115	120	150	225
4a	143	160	200	300
6a	230	240	300	450
e1	43,5	48,6	60,7	91

## Drawings of main façade markings v2

### Principle

This layout shows the proportions between the different components featuring on the **main façade of low buildings** (less than 1.5 m of frontage).

The height of the Renault word is calculated based on the letter "E".

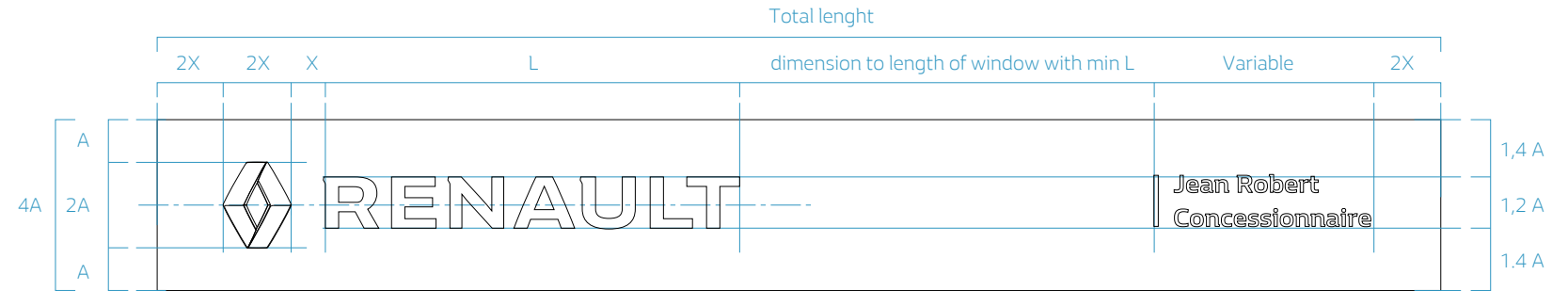

### Key

- 1 Dark grey background in woven-metal mesh
- 2 3D diamond, LED-backlit, with light-diffusing chrome finish
- 3 Renault word in backlit box letters, with white PMMA face, 30/10th mm thick PMMA edges matt black finish
- 4 Backlit vertical strip, made of white LED blocks, edges masked with matt black adhesive
- 5 Backlit Site name, made of white LED blocks, edges masked with matt black adhesive
- 6 Lettering "Dealer", backlit, made of white LED blocks, edges masked with matt black adhesive

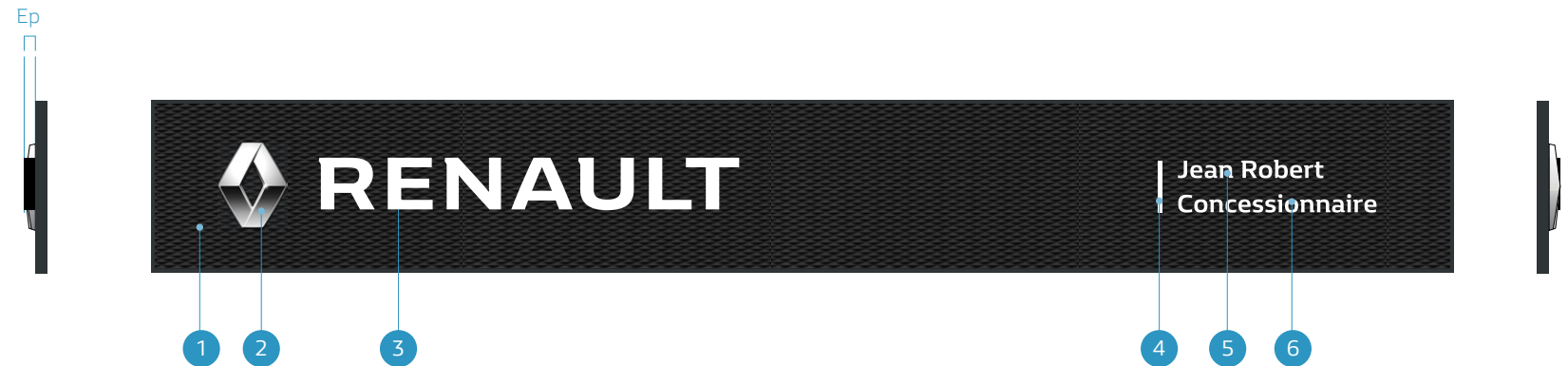

Dimension	Diamond 380	Diamond 670
A	190	335
2A	380	670
4A	760	1340
1,2A	228	402
1,4A	266	469
X	152	268
2X	304	536
L	1854	3269
Ep	72	72

## Layout of Site name v2

### Principle

This layout shows the proportions between the different components of the Site name featuring on the **façades of low buildings** (with less than 1.5 m of frontage).

The height of the Site name is always equal to 33% of that of the Renault word.

NOTE: Dimension e2 represents the thickness of the lettering. Below 30 mm, the letters can not be backlit by LED-blocks and will be made of cut-out white aluminium sheet.

### Key

- 1 Backlit vertical strip, made of white LED blocks, edges masked with matt black adhesive
- 2 Site name, Renault Life bold typography, standard tracking, capitals on first letter of surnames and first names.
- 3 "Dealer" lettering, Renault Life regular typography, standard tracking.

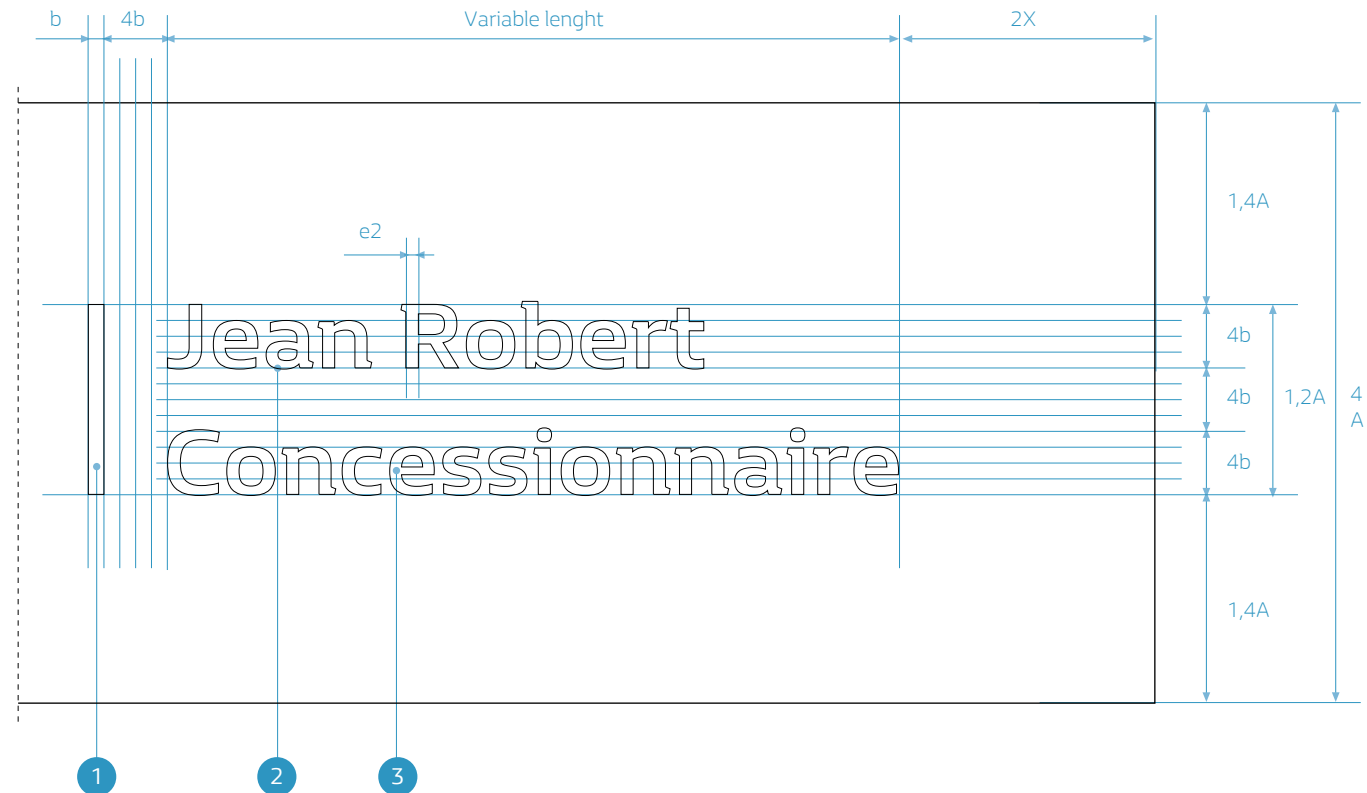

Dimension	Diamond 380	Diamond 670
4A	760	1340
1,4A	266	469
1,2A	228	402
2X	304	536
b	19	33,5
4b	76	134
e2	20,4	36

## Drawings of secondary façade markings v2

### Principle

This layout shows the minimum dimension of the signature on the **secondary façade of low buildings** (less than 1.5 m of frontage).

The secondary façade does not display the Site name.

Dimension Lm represents the minimum length of the façade compatible with the use of this signature on a secondary façade.

The height of the Renault word is calculated based on the letter "E".

### Key

- 1 Dark grey background in woven-metal mesh
- 2 3D diamond, LED-backlit, with light-diffusing chrome finish
- 3 Renault word in backlit box letters, with white PMMA face, 30/10th mm thick PMMA edges matt black finish

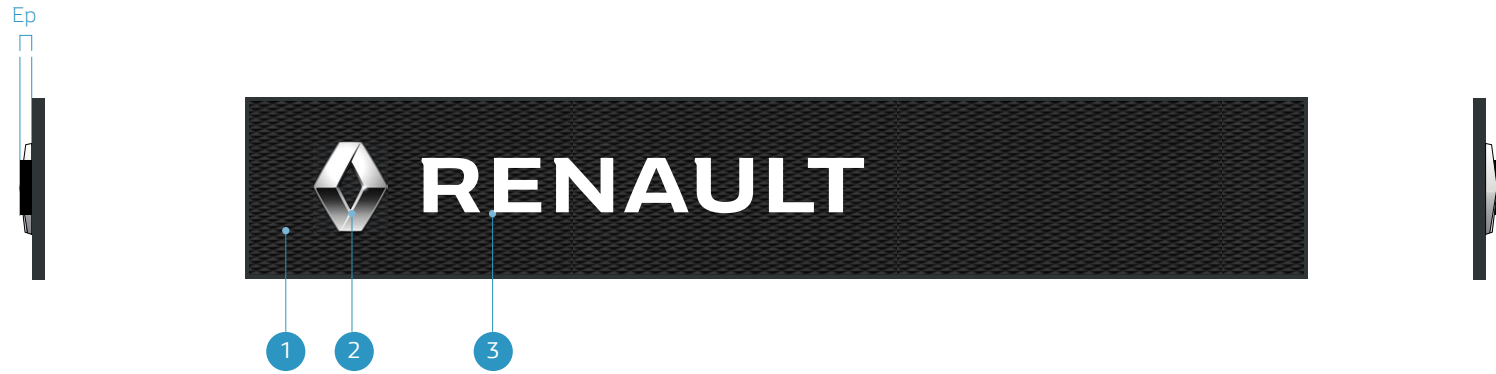
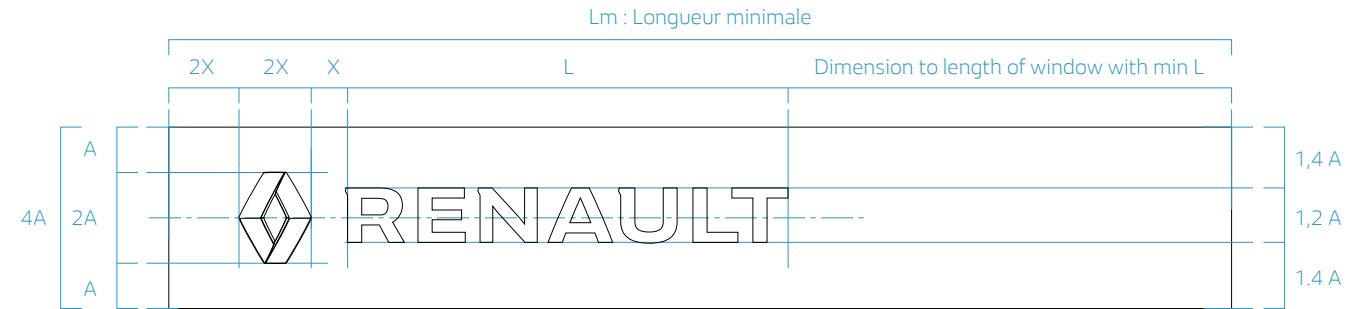

Dimension	Diamond 380	Diamond 670
A	190	335
2A	380	670
4A	760	1340
1,2A	228	402
1,4A	266	469
X	152	268
2X	304	536
L	1854	3269
Lm	4468	7878
Ep	72	72



## Drawings of blind façade markings v2

### Principle

This layout gives the standard dimensions of the signature on blind façades (façades without the glazed sections of a showroom) of **low buildings** (less than 1.5 m of frontage).

The height of the Renault word is calculated based on the letter "E".

### Key

- 1 Dark grey background in woven-metal mesh
- 2 3D diamond, LED-backlit, with light-diffusing chrome finish
- 3 Renault word in backlit box letters, with white PMMA face, 30/10th mm thick PMMA edges matt black finish

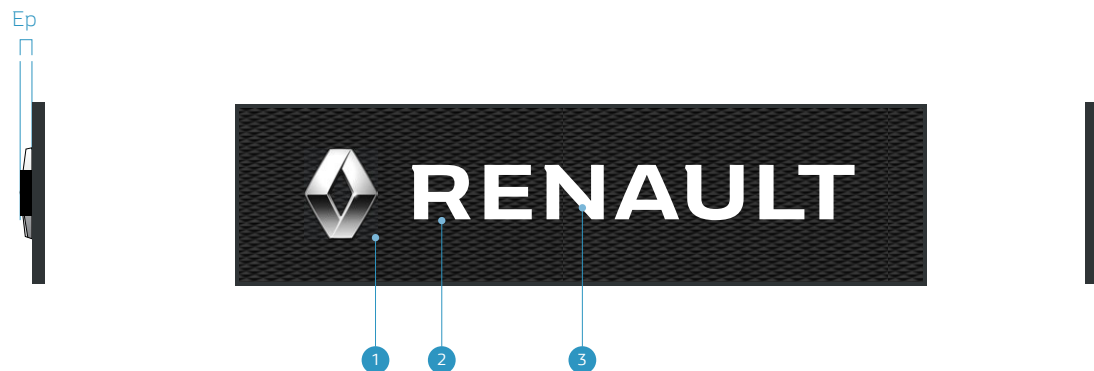
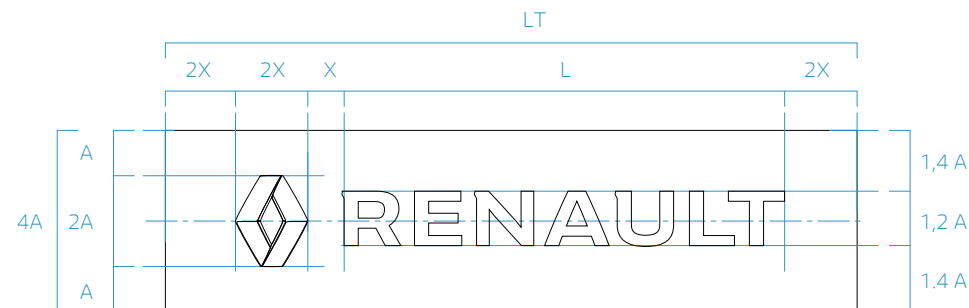

Dimension	Diamond 380	Diamond 670
A	190	335
2A	380	670
4A	760	1340
1,2A	228	402
1,4A	266	469
X	152	268
2X	304	536
L	1854	3269
LT	2918	5145
Ep	72	72

## Site name on a single line v2

### Principle

This layout shows the proportions between the Renault Signature and the Site name on a single line whose height is equal to 50% of that of the Renault word.

This lay-out is to be used on the **main façade of low buildings** (less than 1.5 m of frontage).

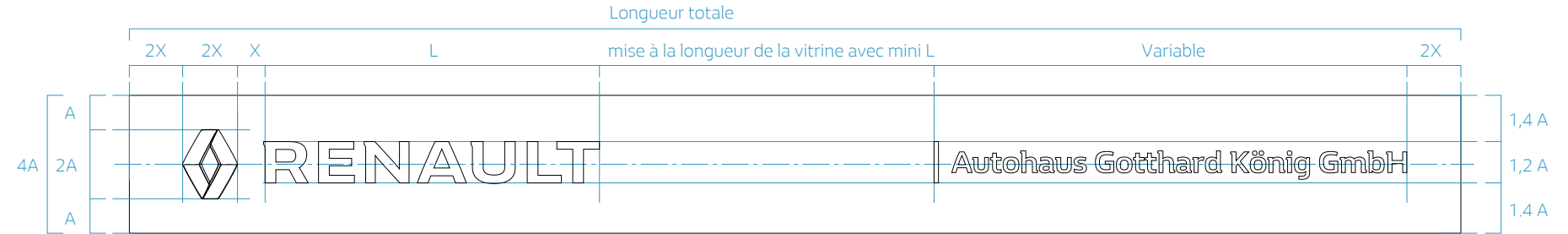

### Key

- 1 Dark grey background in woven-metal mesh
- 2 3D diamond, LED-backlit, with light-diffusing chrome finish
- 3 Renault word in backlit box letters, with white PMMA face, 30/10th mm thick PMMA edges matt black finish
- 4 Backlit vertical strip, made of white LED blocks, edges masked with matt black adhesive
- 5 Backlit Site name, made of white LED blocks, edges masked with matt black adhesive

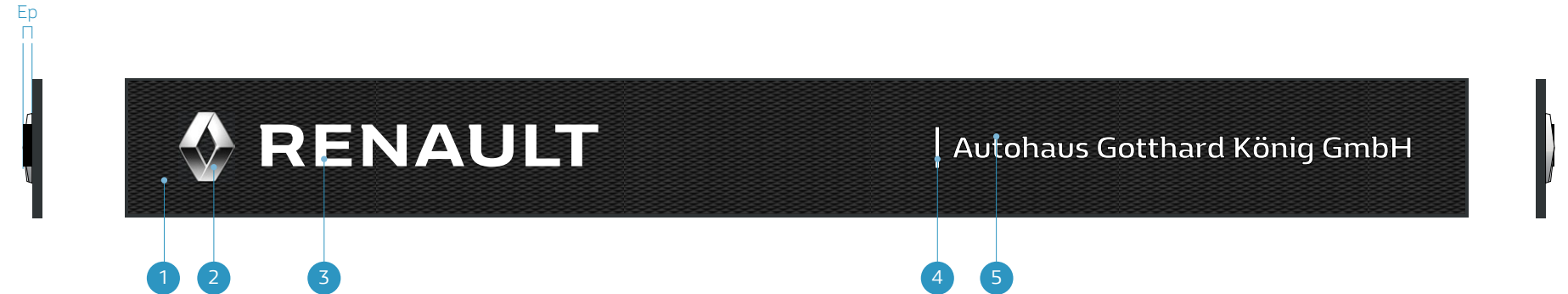

Cote	Diamond 380	Diamond 670
A	190	335
2A	380	670
4A	760	1340
1,2A	228	402
1,4A	266	469
X	152	268
2X	304	536
L	1854	3269
Ep	72	72

## Layout of Site name on a single line v2

### Principle

This layout shows the proportions between the different components of the Site name on a single line.

The height of the Site name is always equal to 50% of that of the Renault word.

NOTE: Dimension e2 represents the thickness of the lettering. Below 30 mm, the letters can not be backlit by LED-blocks and will be made of cut-out white aluminium sheet.

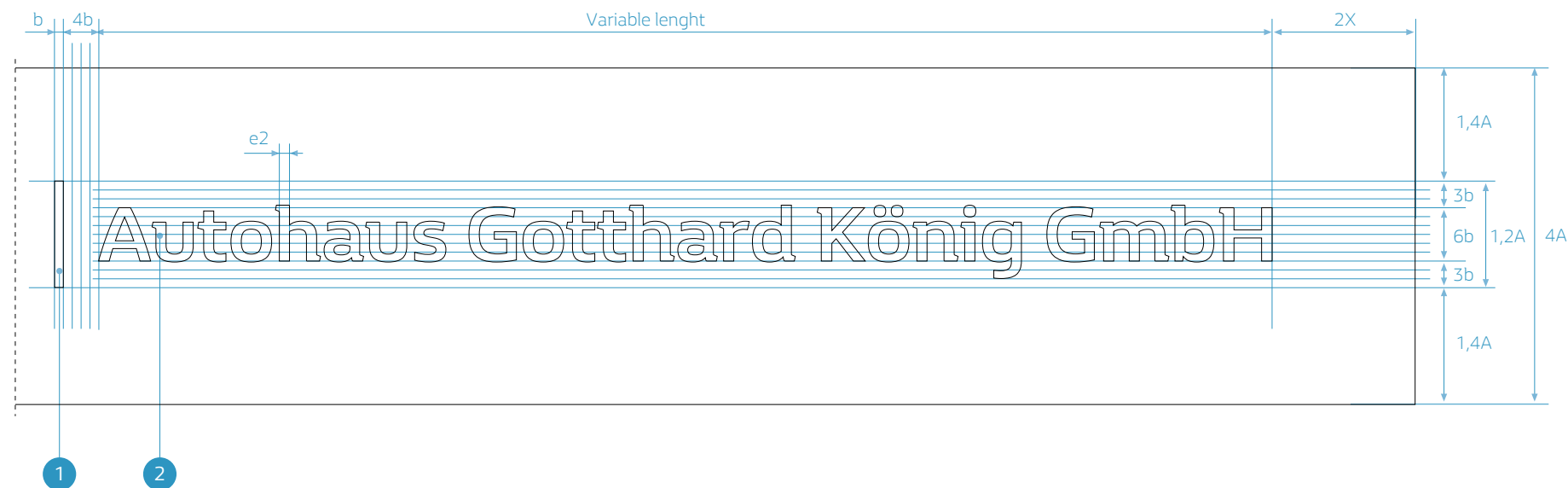

### Key

- 1 Backlit vertical strip, made of white LED blocks, edges masked with matt black adhesive
- 2 Site name, Renault Life bold typography, standard tracking, capitals on first letter of surnames and first names.

Diamond	Diamond 380	Diamond 670
4A	760	1340
1,4A	266	469
1,2A	228	402
2X	304	536
b	19	33,5
3b	57	100
4b	76	133
6b	114	201
e2	23	41

## Correspondence between diamonds and façade heights

### Adaptation principle

The table opposite shows façade heights and corresponding diamond sizes available as standard.

To cater for a variety of specific façade dimensions, each signature may be used for a range of façade heights.

- Example 1.

The 670 mm diamond will cover façades in the height range 1,000 mm to 1,400 mm approximately.

- Example 2.

The 1,800 mm diamond can be used for available heights of façade in the range 2,900 mm to over 4,000 mm.

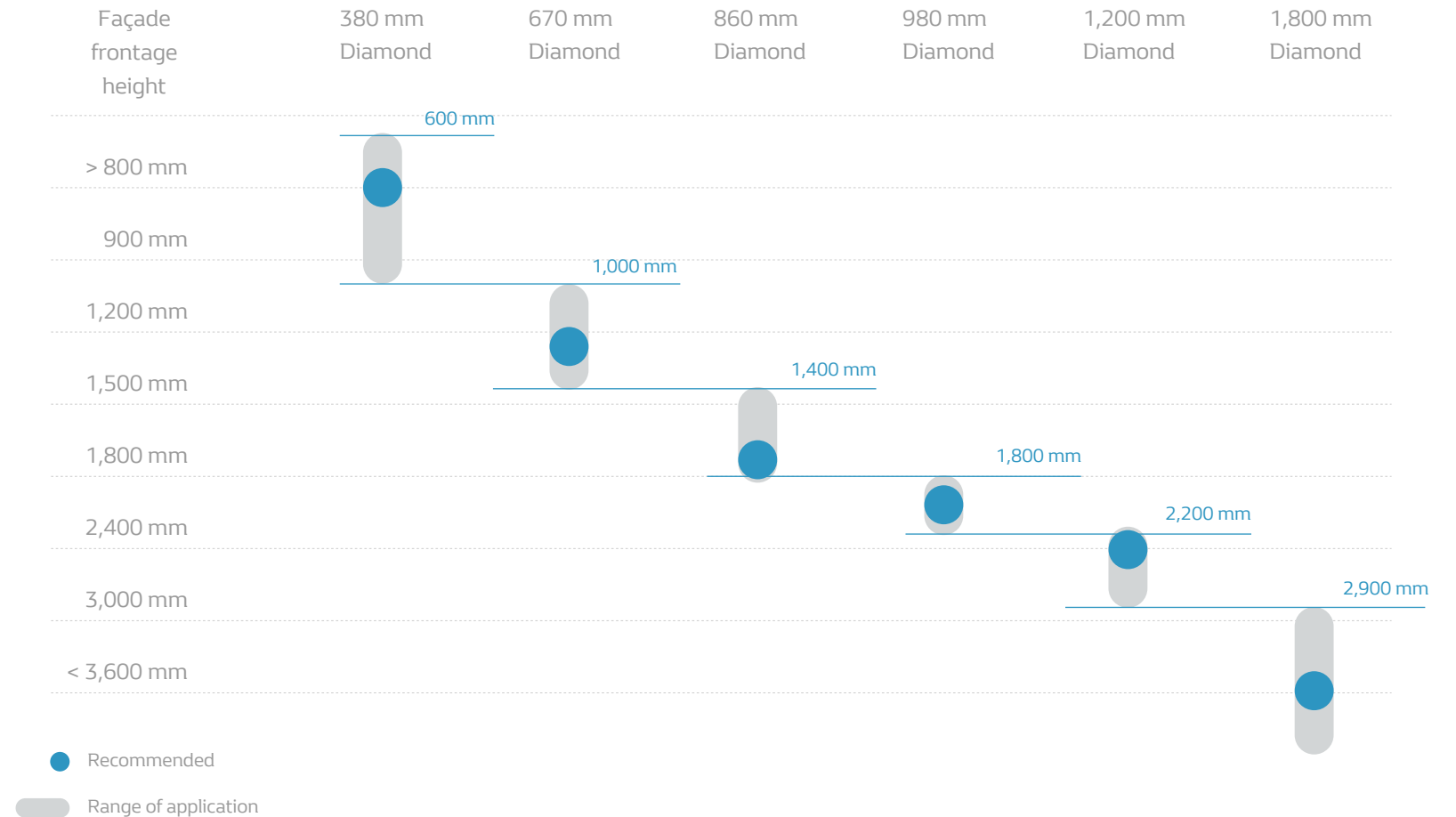

## Use of signature layout drawings

### Choice of layout to use

The table opposite shows the signature layouts and corresponding diamond sizes available as standard.

- Layout v1 is used for the majority of façades.
- Layout v2 is designed to address the potential impact deficit (reduced height of Renault word) with low height façades.
- Only signatures with 380 and 670 mm diamonds can use this layout.

	380 mm Diamond	670 mm Diamond	860 mm Diamond	980 mm Diamond	1,200 mm Diamond	1,800 mm Diamond
Drawings v1			●	●	●	●
Drawings v2	●	●				

## Renault word layout drawings

### Description

The table opposite gives the positioning dimensions for the Renault word lettering of the façade signature.

NOTE. The height of the Renault word is calculated based on the letter "E".

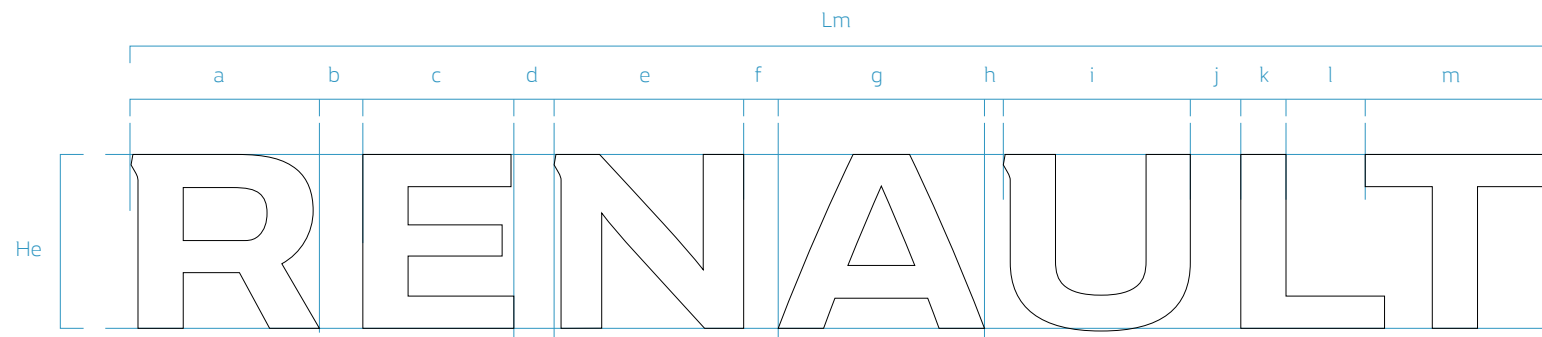

Drawings v2

Drawings v1

Dimension	Lettering 228	Lettering 402	Lettering 430	Lettering 490	Lettering 600	Lettering 900
He	228	402	430	490	600	900
Lm	1854	3269	3497	3984	4878	7317
a	247	435	466	531	650	975
b	57	100	107	122	150	225
c	198	349	373	426	521	782
d	53	93	100	113	163	208
e	249	438	469	534	654	981
f	45	80	85	97	119	179
g	270	477	510	581	712	1068
h	25	44	47	53	65	98
i	245	432	462	527	645	968
j	66	117	125	142	174	261
k	59	105	112	127	156	234
l	104	183	196	223	273	410
m	235	415	444	506	619	928

## Fabrication principle for lettering

### Key

- 1 Backing in 10 or 13 mm expanded PVC
- 2 Edging in opaque black 30/10th mm thick PMMA, internal finish in matt white adhesive, with shoulder for flush mounting letter face
- 3 White chain LEDs, IP65 rated, 6,500° K, luminance 250 cd/m2
- 4 Letter face in white PMMA, thk. 3 mm, bonded along the edge



## Schematic exploded view

### Key

- 1 Converter outside the letter, mounted in the peripheral frame of the woven-metal mesh support
- 2 Backing in 10 or 13 mm expanded PVC
- 3 White chain LEDs, IP65 rated, 6,500° K, luminance 250 cd/m<sup>2</sup>
- 4 Edging in opaque black 30/10th mm thick PMMA, internal finish in matt white adhesive, with shoulder for flush mounting letter face
- 5 Letter face in white PMMA, thk. 3 mm, bonded along the edge

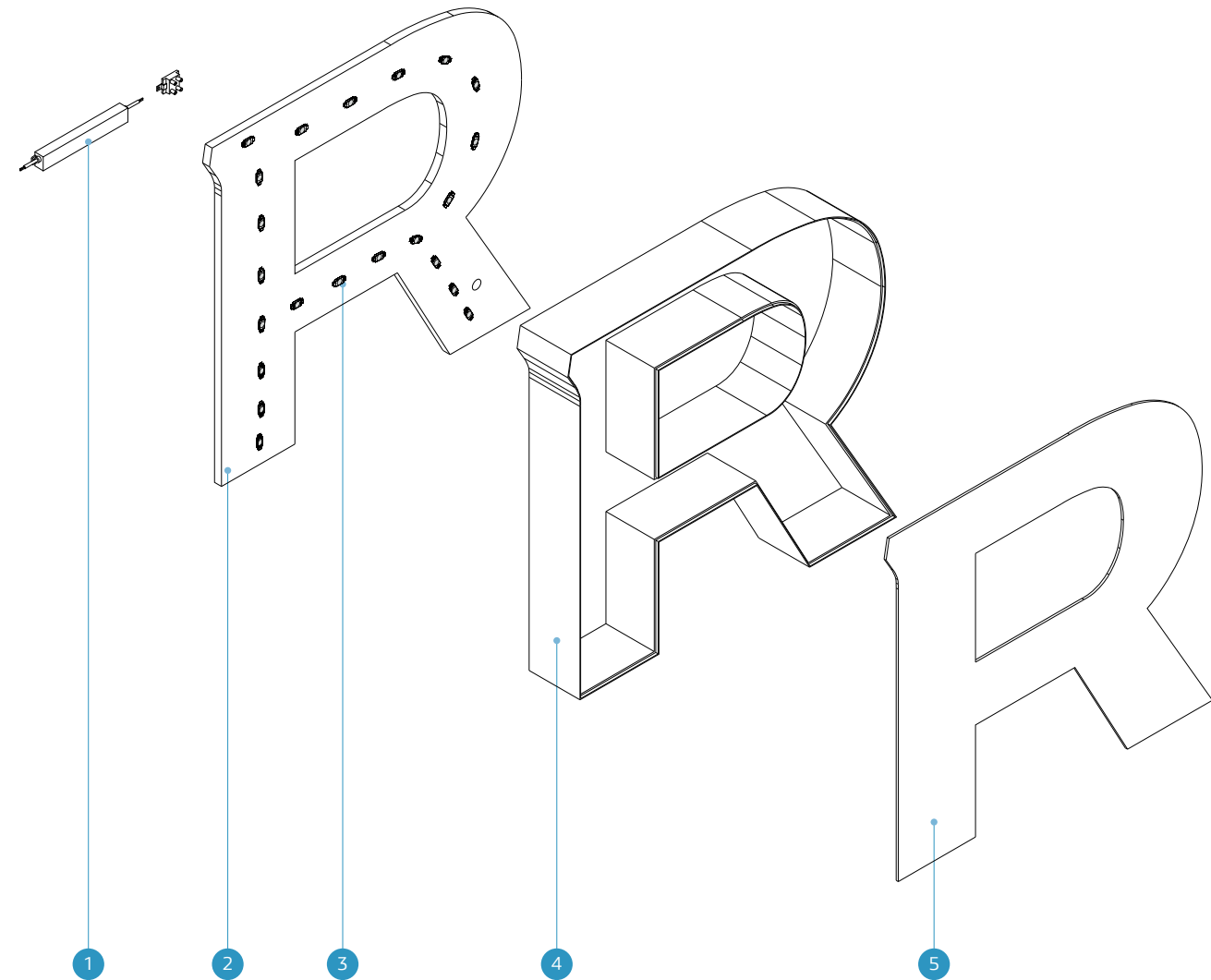



# Lighting for box letters

## Description

Illumination of the lettering face by chain LEDs mounted on the letter backing.

The converter, which is common for a group of letters or for all the letters, is mounted outside the lettering.

## Performances

Chain LED with minimum IP65 protection rating.

Temperature: 6,500° K Cool White.

Mean luminance: 250 cd/m<sup>2</sup> with a maximum of 300 cd/m<sup>2</sup>.

The warranty for all LED lighting systems and parts is 5 years, subject to compliance with conditions of use and maintenance.

Light output reduced by 50% after 50,000 hours operation.

Minimum guaranteed lifetime: 50,000 hours

Supply: 220 volts

12 volt converter with regulated voltage, IP 68 protection.

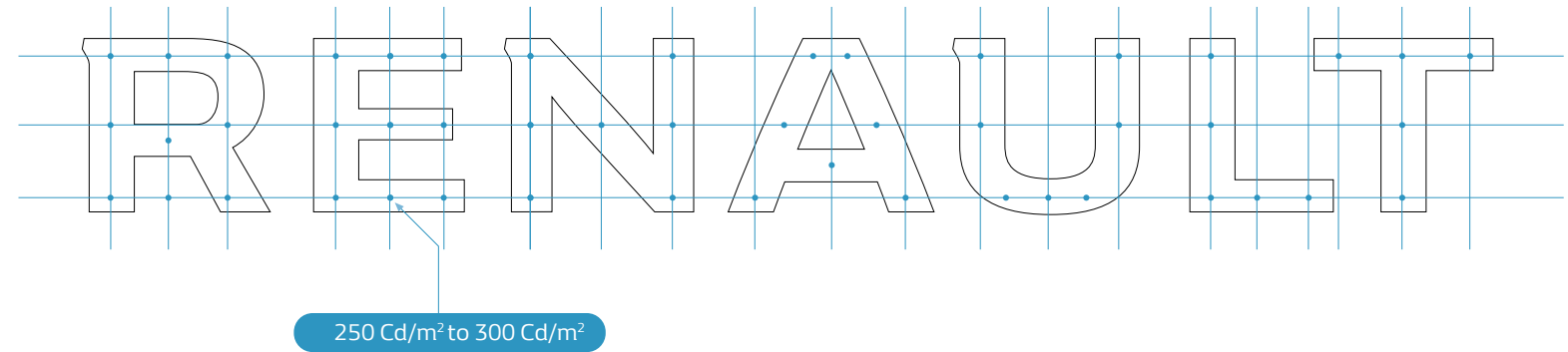

The dots are a schematic representation of the measurement points that should present similar light intensity values in order to obtain even lighting across each of the letters of the Renault word.

The readings, performed with a calibrated luminance meter, should ideally be performed without light interference and at a distance of between 1 and 2 m from the letter face.

## Lighting of 228 mm lettering

### Principle

This recommendation is made on the basis of a 20 lumens module with a luminous efficacy of 90 to 100 lumens/watts.

The instruction remains indicative and shall require, for each letter, a validation and a test for compliance with the performance targets indicated in this document.

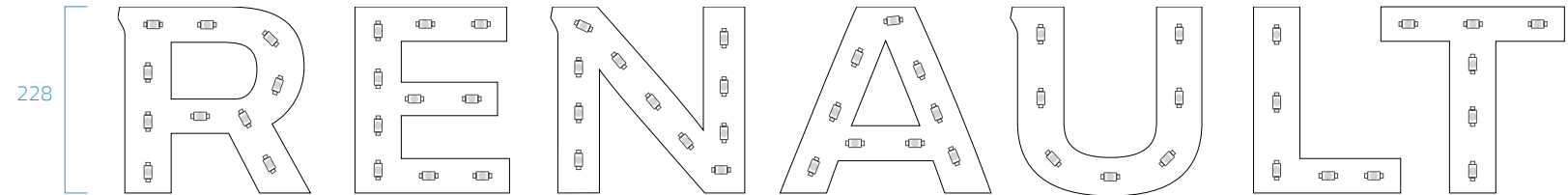

### Description

- Temperature: 6,500° K Cool White.
- Number of LED: approx. 58 modules
- Approximate power consumption: 15 watts
- Supply: 220 volts
- Converter: 15vA

## Lighting of 402 mm lettering

### Principle

This recommendation is made on the basis of a 20 lumens module with a luminous efficacy of 90 to 100 lumens/watts.

The instruction remains indicative and shall require, for each letter, a validation and a test for compliance with the performance targets indicated in this document.

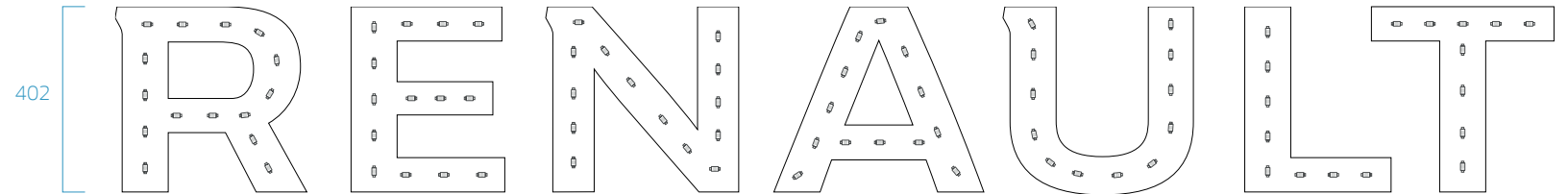

### Description

- Temperature: 6,500° K Cool White.
- Number of LED: approx. 85 modules
- Approximate power consumption: 21 watts
- Supply: 220 volts
- Converter: 35vA

## Lighting of 430 mm lettering

### Principle

This recommendation is made on the basis of a 20 lumens module with a luminous efficacy of 90 to 100 lumens/watts.

The instruction remains indicative and shall require, for each letter, a validation and a test for compliance with the performance targets indicated in this document.

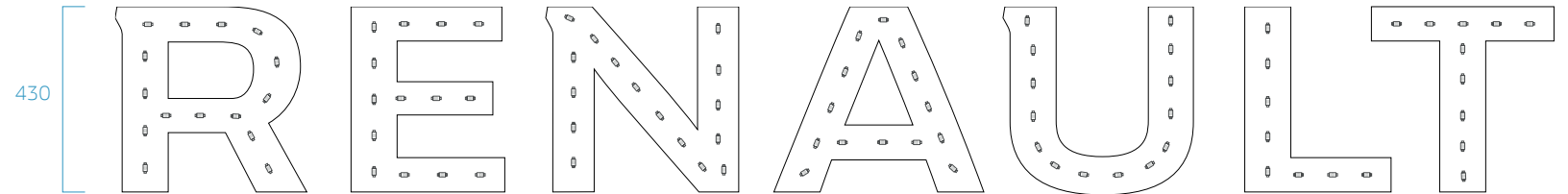

### Description

- Temperature: 6,500° K Cool White.
- Number of LED: approx. 91 modules
- Approximate power consumption: 22 watts
- Supply: 220 volts
- Converter: 35vA

## Lighting of 490 mm lettering

### Principle

This recommendation is made on the basis of a 20 lumens module with a luminous efficacy of 90 to 100 lumens/watts.

The instruction remains indicative and shall require, for each letter, a validation and a test for compliance with the performance targets indicated in this document.

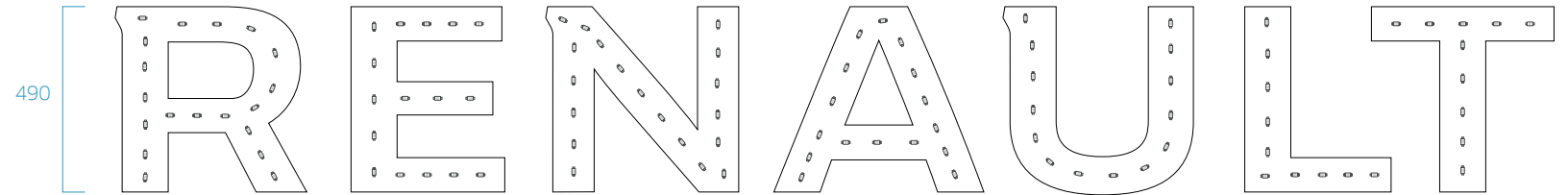

### Description

- Temperature: 6,500° K Cool White.
- Number of LED: approx. 104 modules
- Approximate power consumption: 25 watts
- Supply: 220 volts
- Converter: 35vA

## Lighting of 600 mm lettering

### Principle

This recommendation is made on the basis of a 20 lumens module with a luminous efficacy of 90 to 100 lumens/watts.

The instruction remains indicative and shall require, for each letter, a validation and a test for compliance with the performance targets indicated in this document.

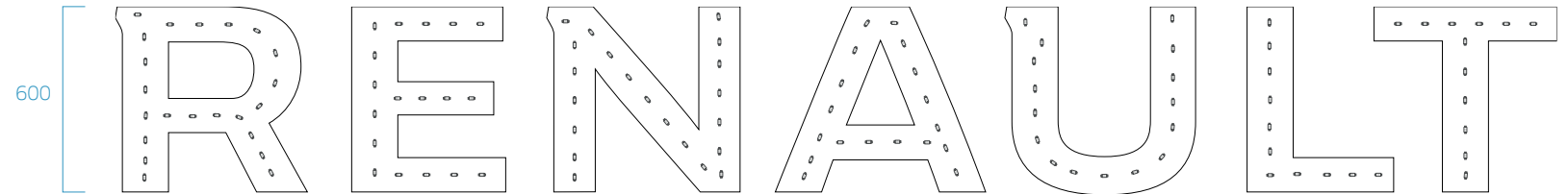

### Description

- Temperature: 6,500° K Cool White.
- Number of LED: approx. 118 modules
- Approximate power consumption: 28 watts
- Supply: 220 volts
- Converter: 35vA

## Lighting of 900 mm lettering

### Principle

This recommendation is made on the basis of a 20 lumens module with a luminous efficacy of 90 to 100 lumens/watts.

The instruction remains indicative and shall require, for each letter, a validation and a test for compliance with the performance targets indicated in this document.

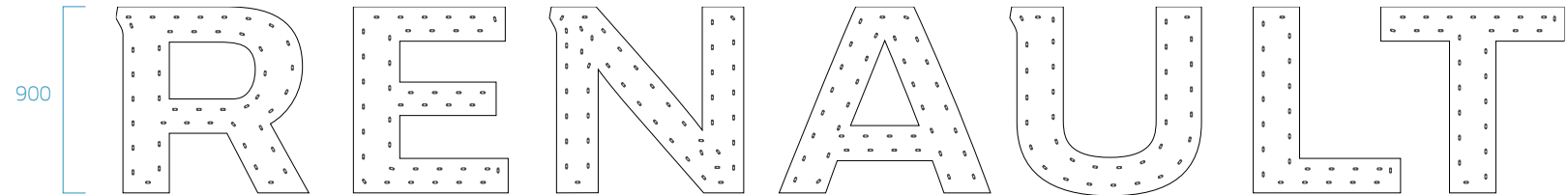

### Description

- Temperature: 6,500° K Cool White.
- Number of LED: approx. 260 modules
- Approximate power consumption: 63 watts
- Supply: 220 volts
- Converter: 100 vA