



**RENAULT**  
La vie, avec passion

Renault Store - Application guide

# Delivery area



# Contents

---

## **General**

Introduction	4
General view	5
Principle of symmetry	6
Colours & materials	7

---

## **Technical principles**

Layout methodology	9
Layout framework	10
Adaptation of components	11
Construction drawings	14
Vehicle layouts	15
Specific cases	16
Drawings of the yellow wall	18
6 m configuration with 1 vehicle	19
8 m configuration with 1 vehicle	22
12 m configuration with 2 vehicles	28
18 m configuration with 3 vehicles	40
20 m configuration for more than 3 vehicles	58

# General



## Introduction

The delivery of a new vehicle is a key event, charged with emotion, and an essential step in the relationship being built between the Renault Brand and its customer.

In order to attribute to this special time the importance it deserves, the delivery area has been fully rethought. It is now located in the showroom, it bears the colours of the Brand and features its own distinctive signage, with the effect of sacralising the vehicle being delivered. Verticals bear communications messages addressing the customer, while a community display wall shows happy customers attending the delivery as spectators, completing the effect.

This space demonstrates the importance and consideration that Renault bears its customers. It reassures, dramatizes a special moment and may even be an occasion for additional sales, with a unit presenting accessories related to the road.

Moreover the delivery area is now easily accessible from the new vehicle preparation area, and includes an "exit" to make things easier for the customer once the hand-over has been completed.



## General view

### Description

The Delivery Areas comprise the following components:

- 1 Yellow wall comprising the Delivery Area signage.
- 2 A Renault Community visual
- 3 Grey wall with Renault Commitments and an accessories cabinet.
- 4 Price display modules with the customized visuals and USPs of the delivered vehicle.
- 5 Yellow strips marking out the position of vehicles
- 6 Specific lighting

- A discussion area comprising two stools and a bar table.

### Modularity of areas

These elements can be combined in different lengths to adapt to the different dealership layouts.

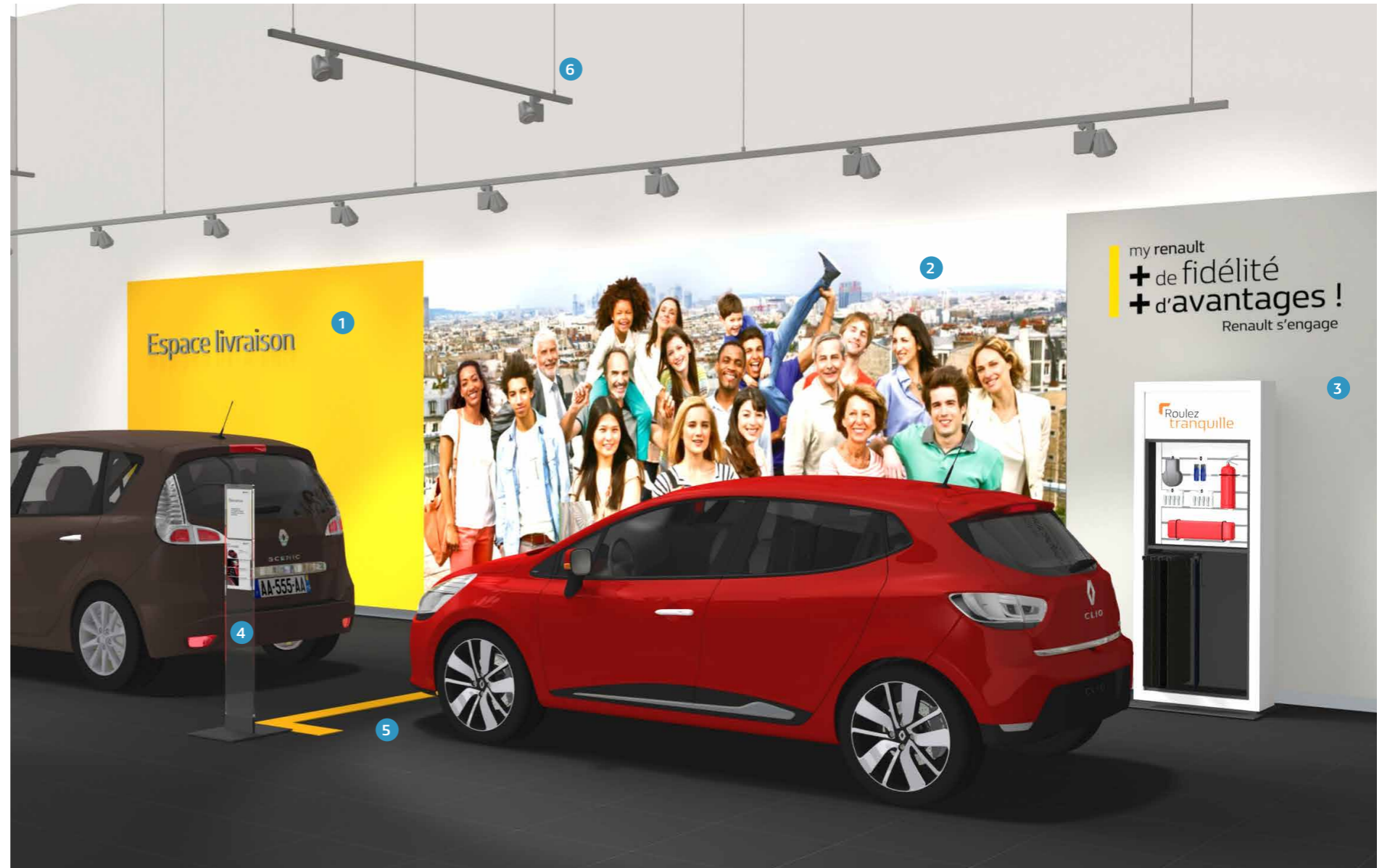

## Principle of symmetry

### Principle

The layout of the area must take into account the position of the exit for vehicles.

The yellow wall is installed against the wall which comprises the exit.

The configurations are completely symmetrical, either installed from left to right or right to left.

To make it easier to read the document, the following layout diagrams illustrate Delivery Area layouts where the exit is located on the left-hand side.

### Key

- 1 Delivery area layout with the exit on the left.
- 2 Delivery area layout with the exit on the right.

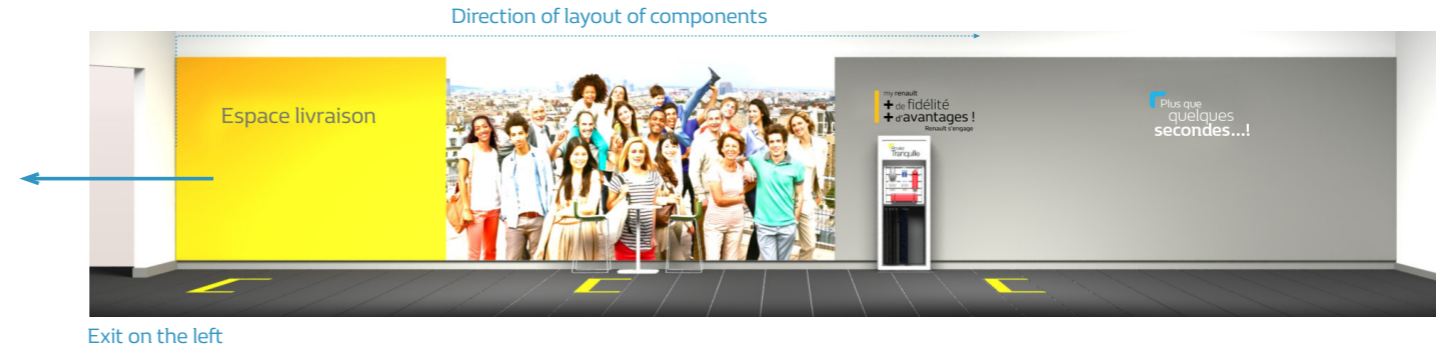

## Colours & materials

### Key

- 1 RAL 1003 extruded PVC strip  
30% gloss satin finish
- 2 RAL 9006 grey lacquered PMMA or printed on fabric
- 3 Painted wall or stretched fabric Pantone yellow 7408 U  
Matt finish 1003 RAL
- 4 Adhesive visual or stretched fabric
- 5 ARPER CATIFA 46 stool, Chrome base, 76 cm high  
Bi-colour white and green polyethylene shell ref PO  
00207 (same as Brand bar)  
Melamine finish round table d. 70 cm and h. 105 cm,  
Base in gloss-finish chrome-plated steel
- 6 Adhesive marking or printed Pantone 7408 U Yellow  
and Black
- 7 Painted wall or stretched fabric Pantone Grey 430 U  
Matt finish 7045 RAL
- 8 Adhesive marking or stretched fabric, White and colour  
related to communications message
- 9 RAL 9010 matt painted walls

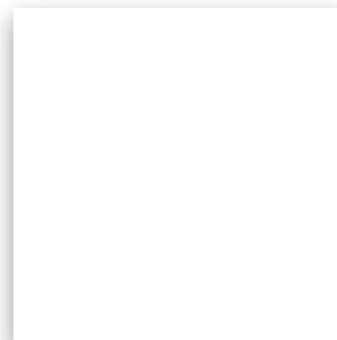
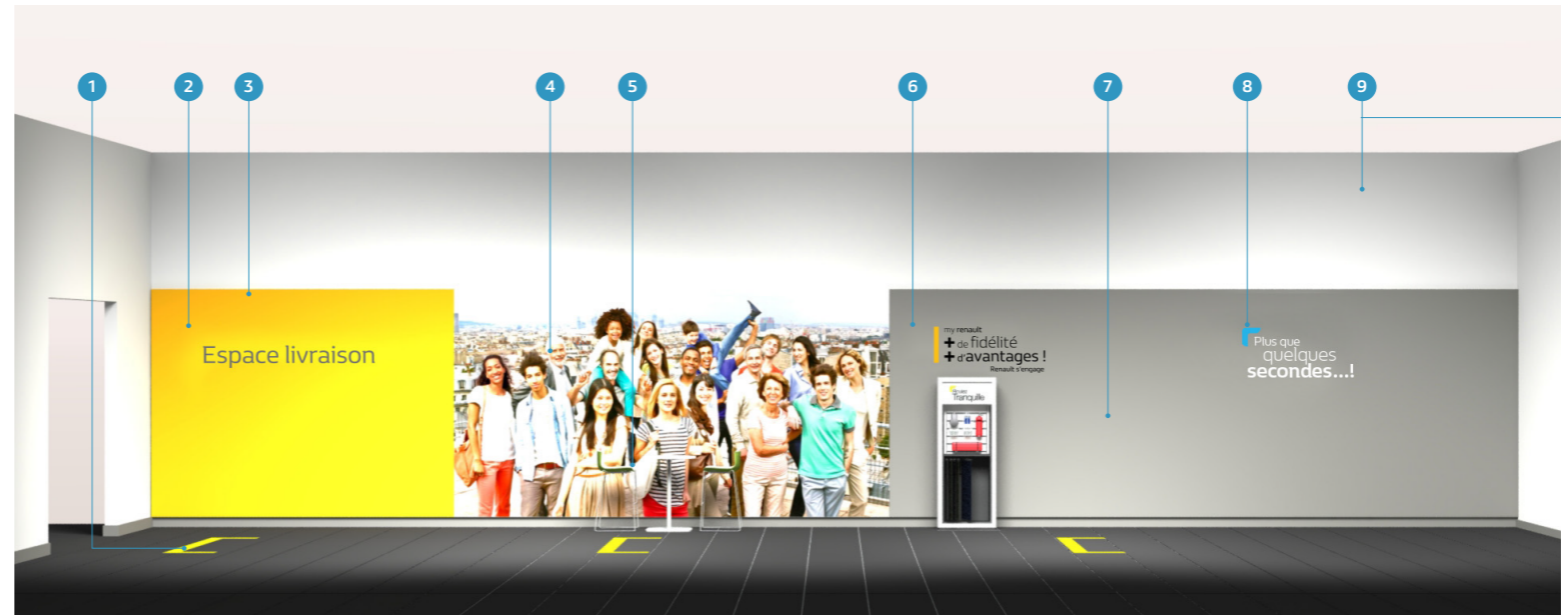

**RAL 9010 white**

Walls



**RAL 9006 grey or Pan-  
tone grey 427 C**

- Markings in lacquered  
PMMA



**RAL 7042 grey or Pan-  
tone 430 U**

- Grey wall



**RAL1003 or Pantone  
7408 EC yellow**

- Area markings

# Technical principles





## Layout methodology

The purpose of this document is to help to gain an understanding of the principles governing the implementation and positioning of the various components used to create a Delivery Area, adapted to the constraints of each dealership.

This area comprises several components which are combined depending on the available surface area: the yellow wall, the grey wall, the Renault Community visual, the accessories and reception units, communications messages, ground markings and specific lighting.

- 1 To start off, we set up the yellow wall near the vehicle exit (either on the left or right): length of 2, 4 or 6 m
- 2 Then the Renault Community visual is positioned with the waiting area unit if there is enough space (if not, move on to point 3):
  - 4 or 6 m wide, for areas comprising 2 to 3 vehicles,
  - 8 m wide, for areas comprising more than 3 vehicles.
- 3 Then the grey wall comprising the commitment and Delivery Accessories Unit centred in this grey section:
  - 2 m wide, if the Delivery Accessories Unit is 1 m wide,
  - 4 m wide, if the Delivery Accessories Unit is 2 m wide.
- 4 Finally, depending on the available length, the grey wall is deployed over at least 2 m.  
On this grey section, communications messages are positioned separated by at least 2 m.
- 5 The layout of vehicles within the Delivery Area is finalized with an adhesive marking positioned in front of each vehicle.

Note: Layouts using identical widths between the various components are to be avoided. The recommended surface area for each vehicle is 36 m<sup>2</sup>.

## Layout framework

### Principle

To simplify implementation and unify Delivery Areas, layout frameworks are defined:

- **Layout framework for the vertical wall**

The components shall be set out at a height of 3,000 mm and spaced 2,000 mm apart.

- **Ground layout framework**

The ground layout framework is 6,000 x 6,000 mm.

The yellow strips enable the vehicles to be positioned within the Delivery Area.

They are placed 2,000 mm away from the upper edge (side wall), and 850 mm away from the front of each framework position.

### Key

- ① Layout framework for the vertical wall
- ② Ground layout framework

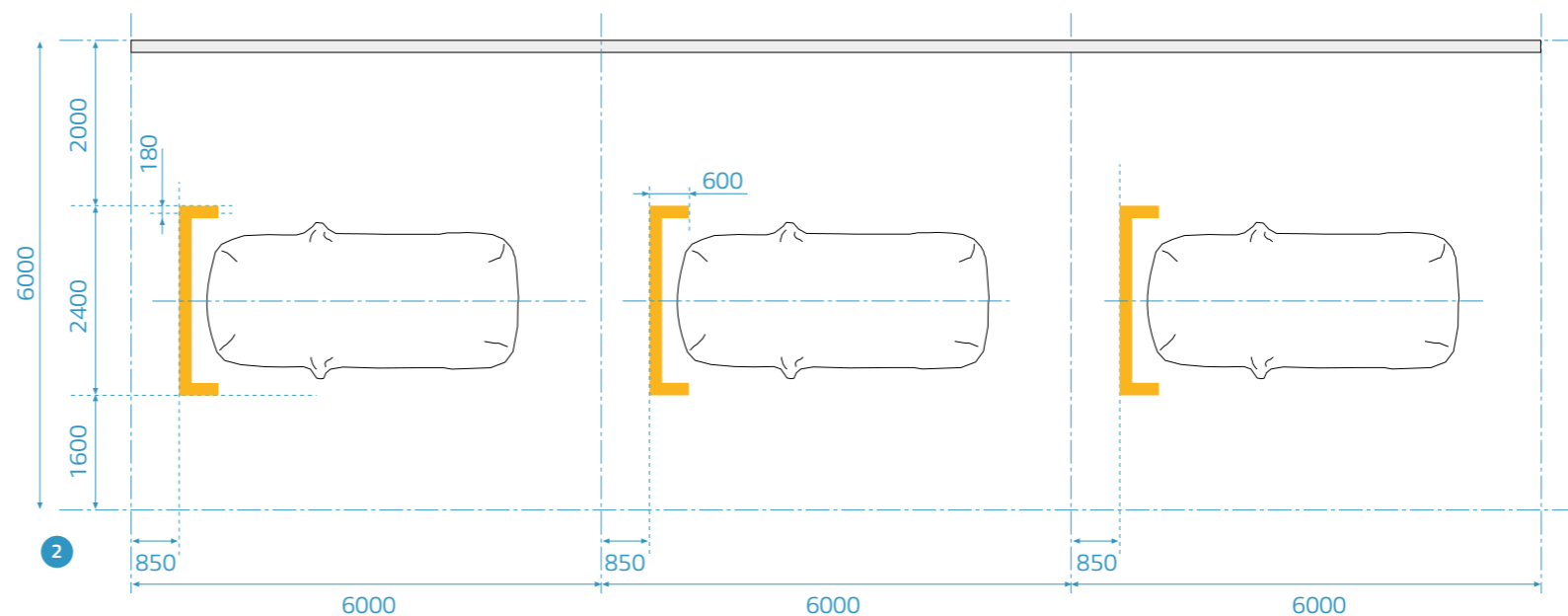
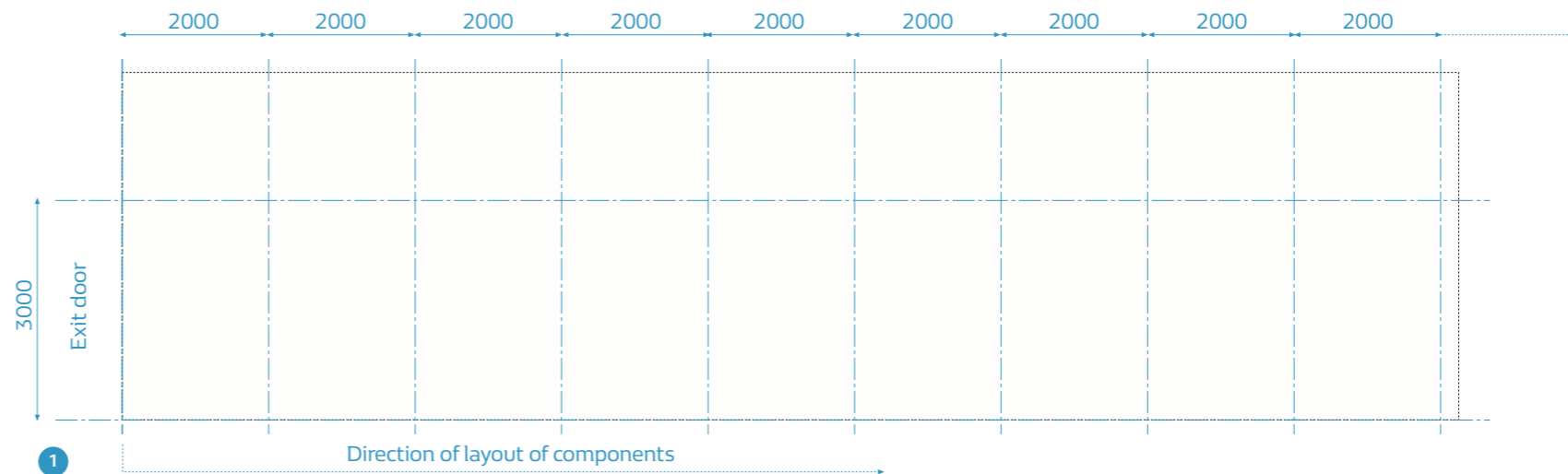

# Adaptation of components

## Yellow wall and Renault Community visual

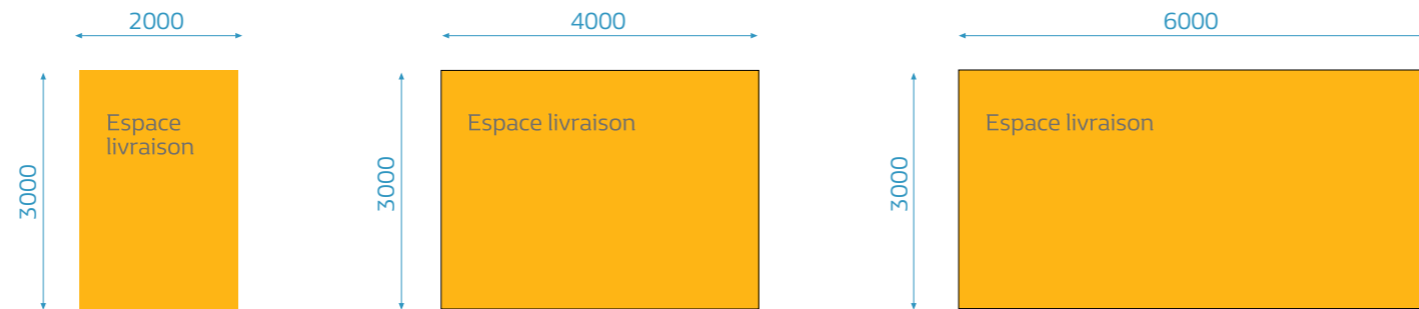

Le mur jaune



Renault Community visual

## Adaptation of components

### The grey wall with 1,000 mm delivery unit

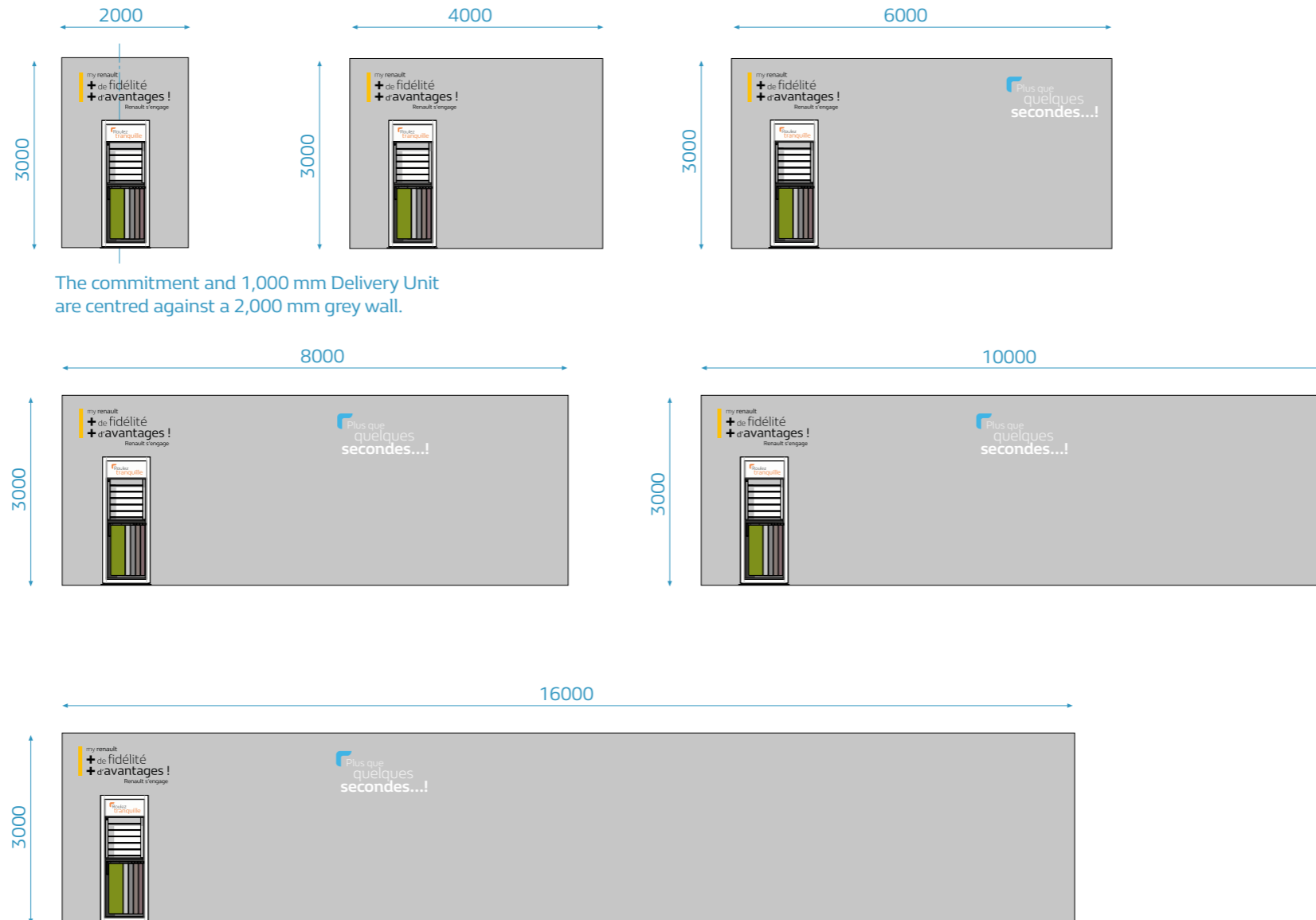

## Adaptation of components

### The grey wall with 2,000 mm delivery unit



The commitment and 2,000 mm Delivery Unit are centred against a 4,000mm grey wall.

## Construction drawings

### Principles

#### 1 Discussion area

The unit is centred with regards to the Renault Community visual.

#### 2 Accessories unit

The accessories unit is always centred in a 2,000 mm or 4,000 mm grey panel.

#### 3 Yellow wall

The "DELIVERY AREA" message is positioned 340 mm from the left-hand edge.

#### 4 Commitment

The commitment is centred in the grey wall and aligned with the bottom of the "DELIVERY AREA" message.

#### 5 Communications messages

Their top edge is aligned at a distance of 275 mm from the upper edge of the complementary grey wall.

They are to be created along the central axis of a 2,000 mm panel, with the following maximum dimensions:

H. 750 x W. 1,600 mm. Between commitments and communications messages, a blank grey of 2,000 mm should be inserted. The same applies between two communications messages; a 2,000 mm blank grey panel should be inserted between them.



## Vehicle layouts

### Principle

Vehicles can be installed in three different ways:

- In line layout,
- Perpendicular layout
- 45° angle layout.

The base area assigned to each vehicle is 6 x 6 m, enabling the creation of a fluid area of traffic around vehicles and the installation of a discussion area.

A single installation option for each area shall be chosen according to the available surface area, the number of vehicles and the position of the exit.

### Vehicle lighting

Please refer to the showroom lighting application guide.

### Description

- 1 In-line layout (parallel to wall)
- 2 Perpendicular layout (Perpendicular to the wall)
- 3 Layout at a 45° angle

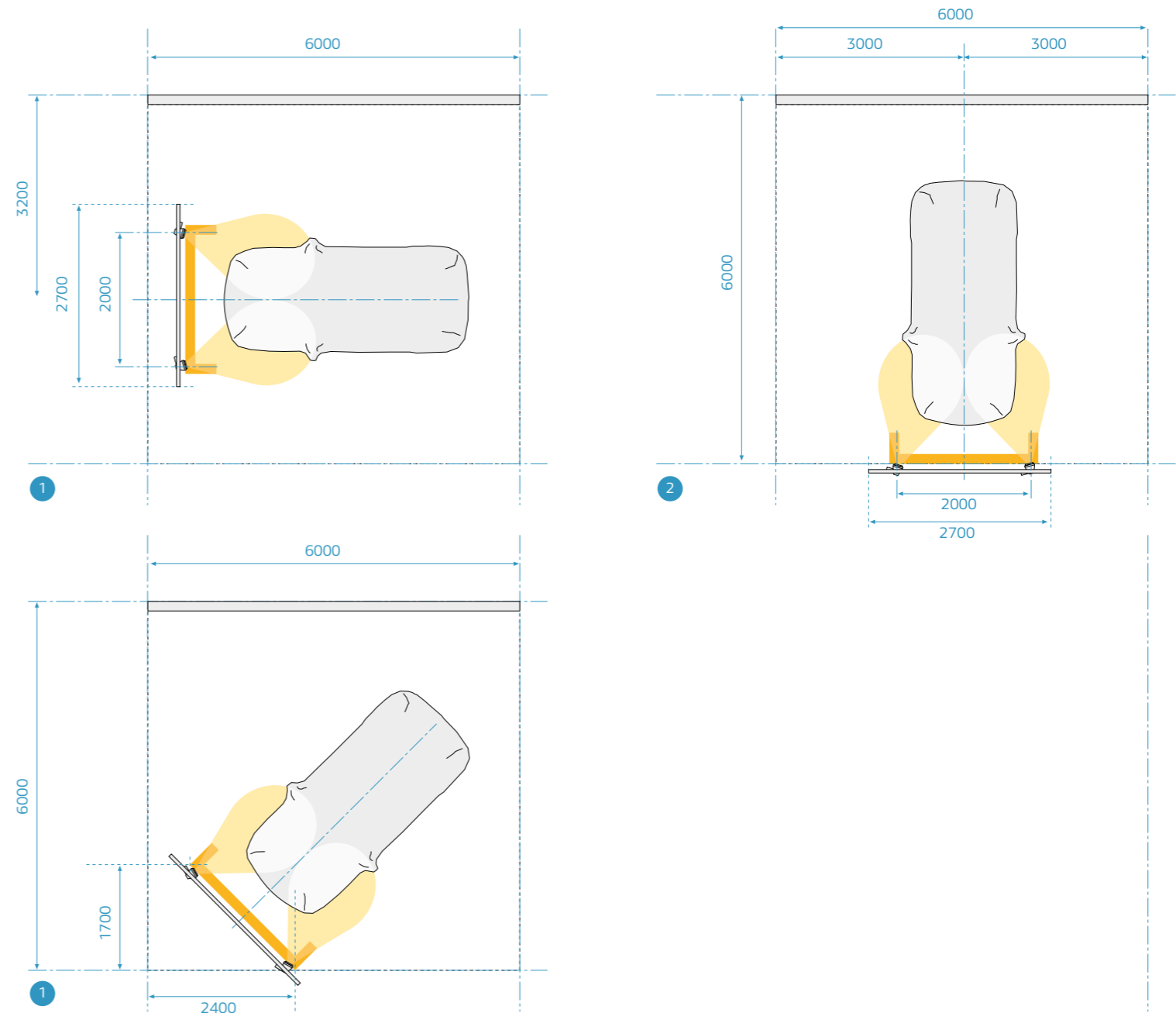

## Specific cases

### Glass façade

When the Delivery Area is installed in front of a glass façade, the following principles should be complied with:

- The opaque section of the wall may not take up more than 2/3 of the length of the glass façade.
- Masking of the upper glass section above the wall is recommended over a maximum height of 600 mm to promote the perception of lighting and avoid backlighting.

### Description

- 1 Stretched fabric or plasterboard wall on a frame
- 2 Masking of the upper glass section over a maximum height of 600 mm:  
Stretched fabric, opaque white adhesive or plasterboard partition, matt white finish RAL 9010
- 3 Glass façade
- 4 Solution for full-height masking of glass façade using OneWay type micro-perforated adhesive, matt or satin finish.

Note:

Attention should be paid to the reverse side depending on the type of environment (workshop, exterior, etc).

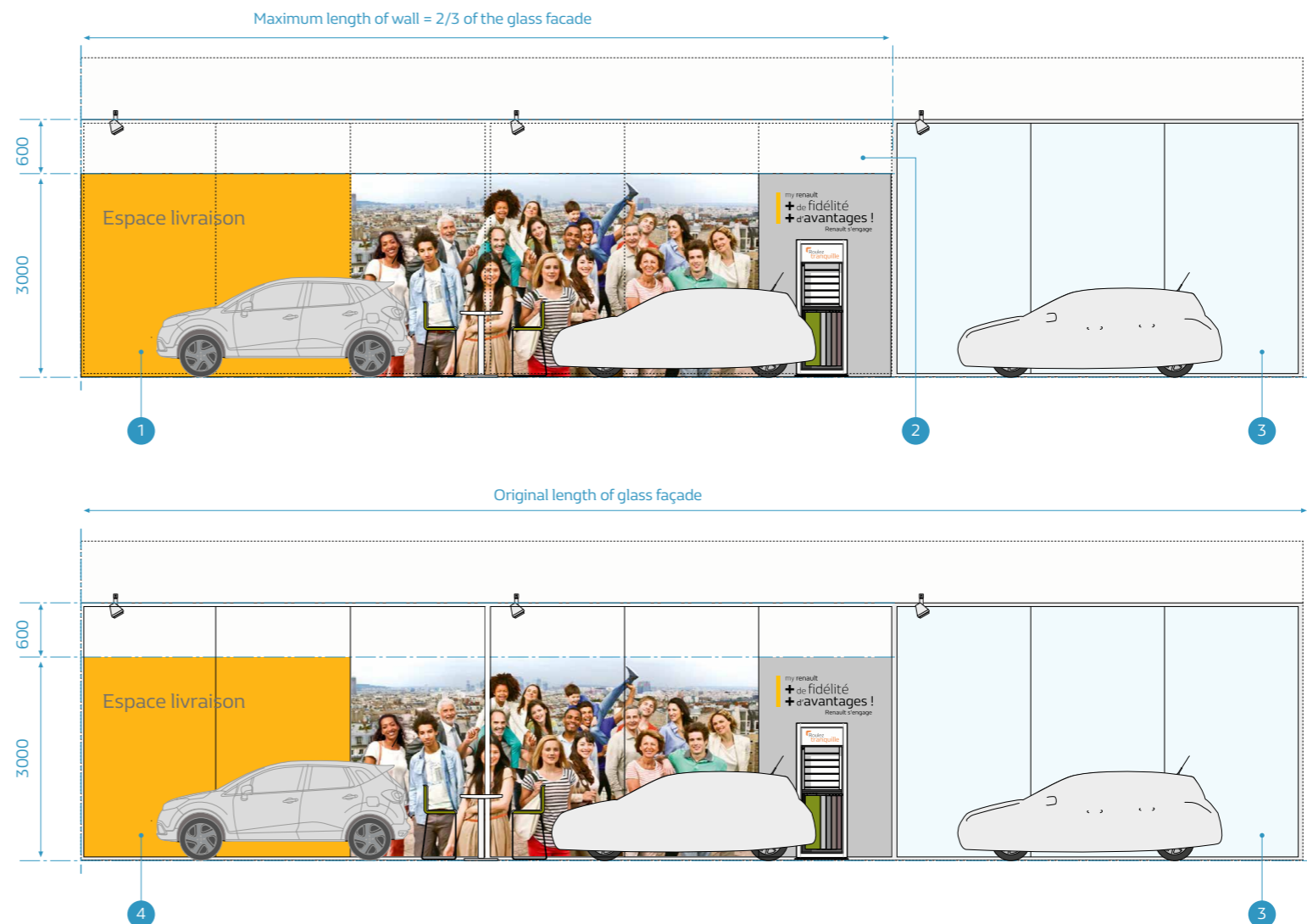



## Specific cases

### Standalone partition

When the Delivery area cannot be located against a wall or a glass façade, it is possible to use standalone partitions in stretched fabric or plasterboard over frame.

### Description

- 1 Front: Stretched fabric or plasterboard wall on a frame
- 2 Back: coating in RAL 9010 or RAL 7042 grey

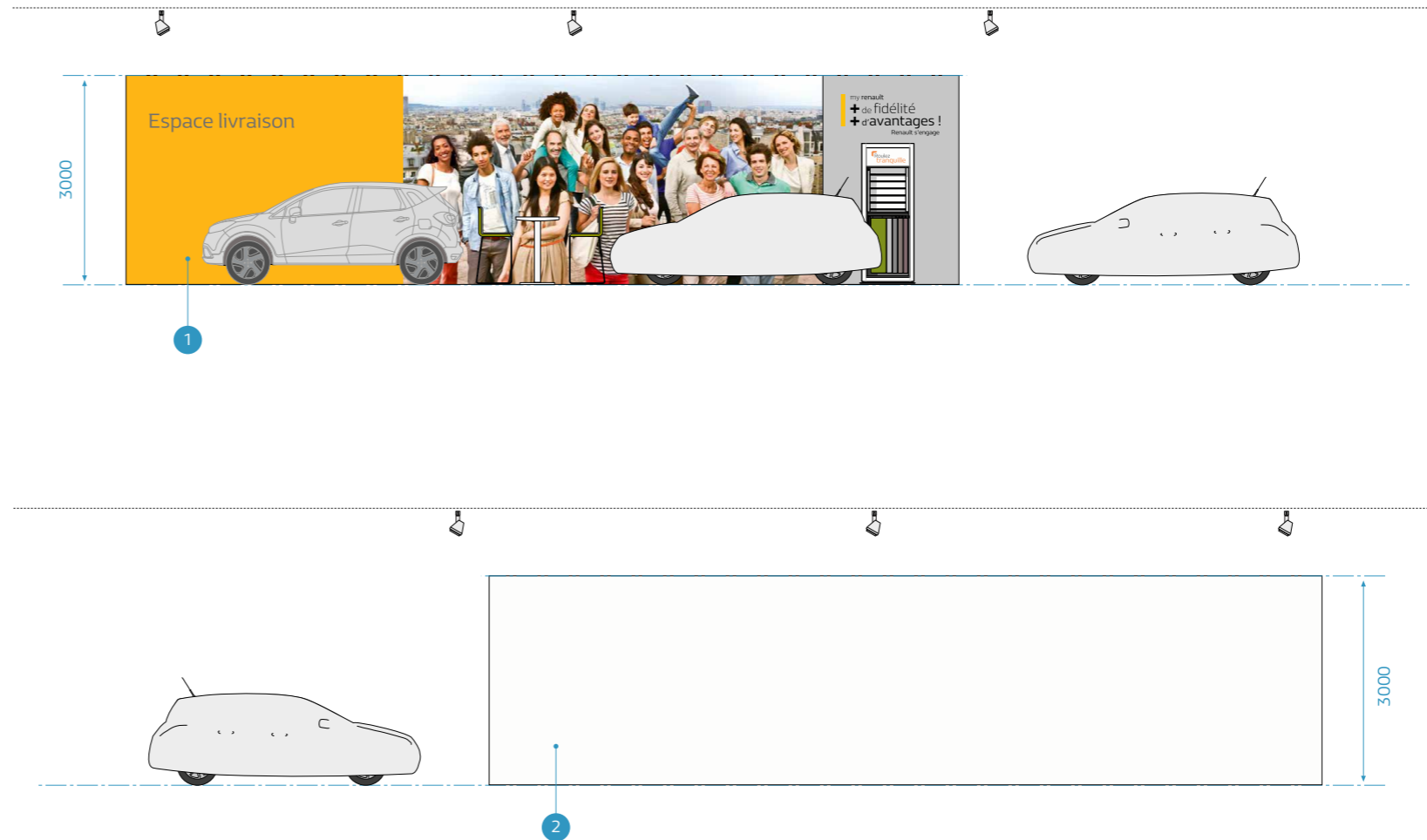

## Drawings of the yellow wall

### Key

- ① Drawings of the 2,000 mm yellow wall
- ① Drawings of the 4,000 mm and 6,000 mm yellow wall

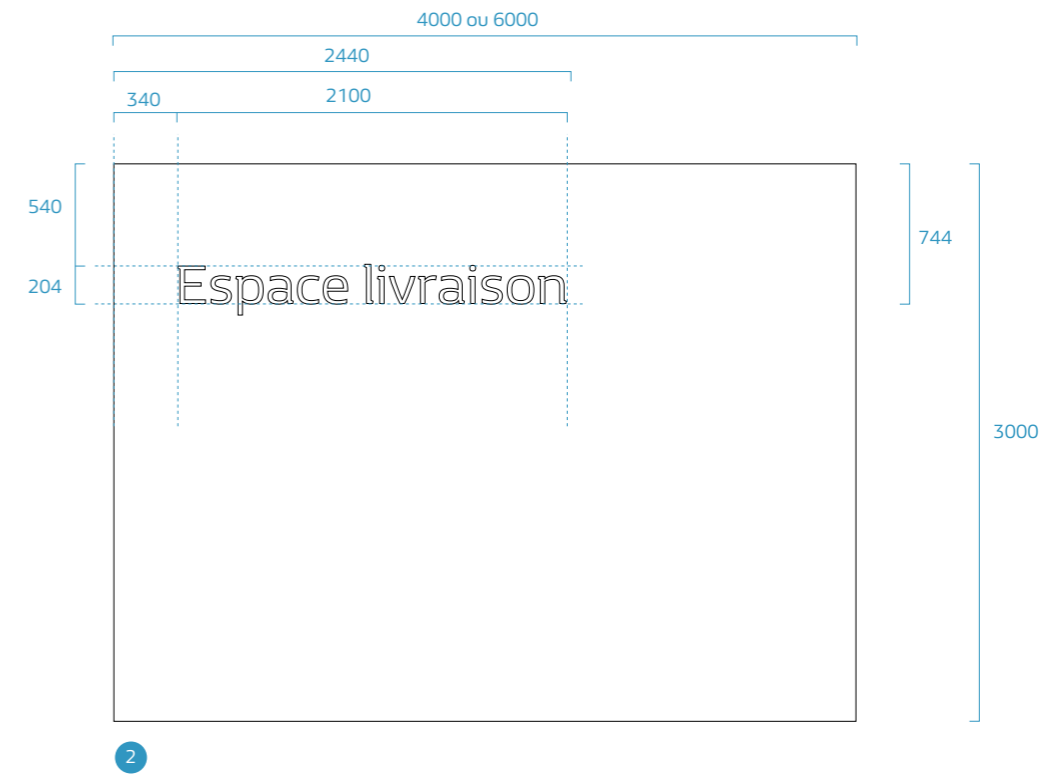
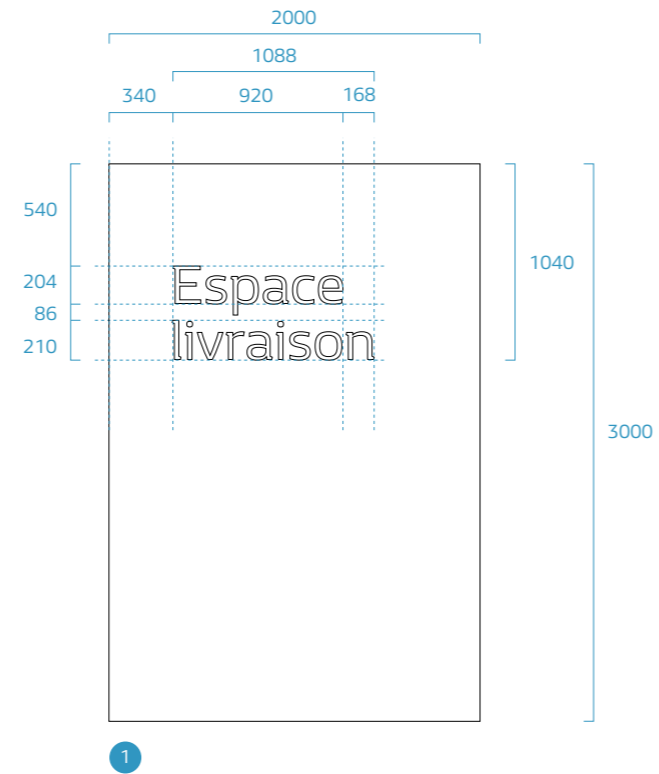

## 6 m configuration with 1 vehicle

### In-line installation of the vehicle

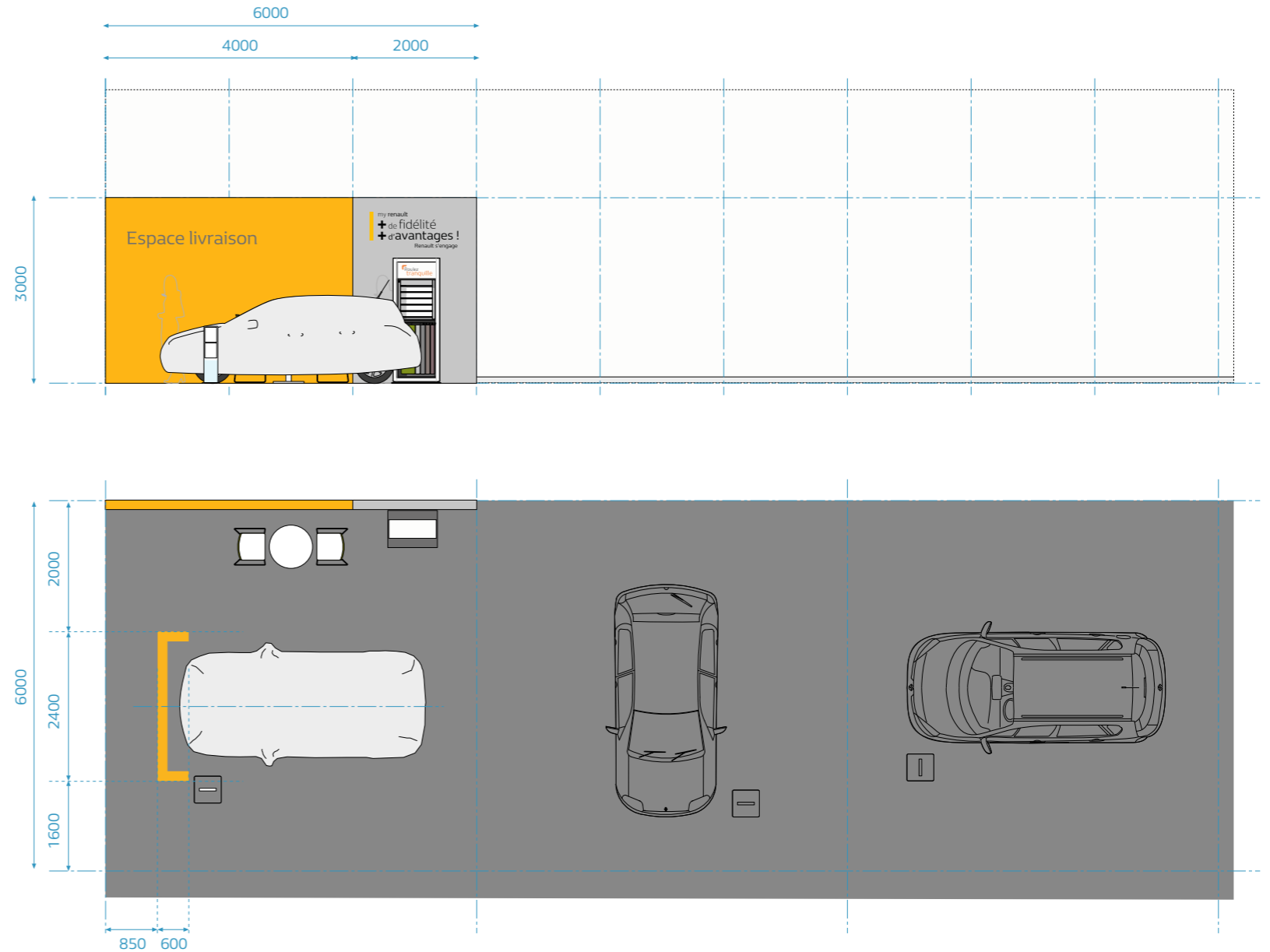

## 6 m configuration with 1 vehicle

### **Perpendicular installation of the vehicle**

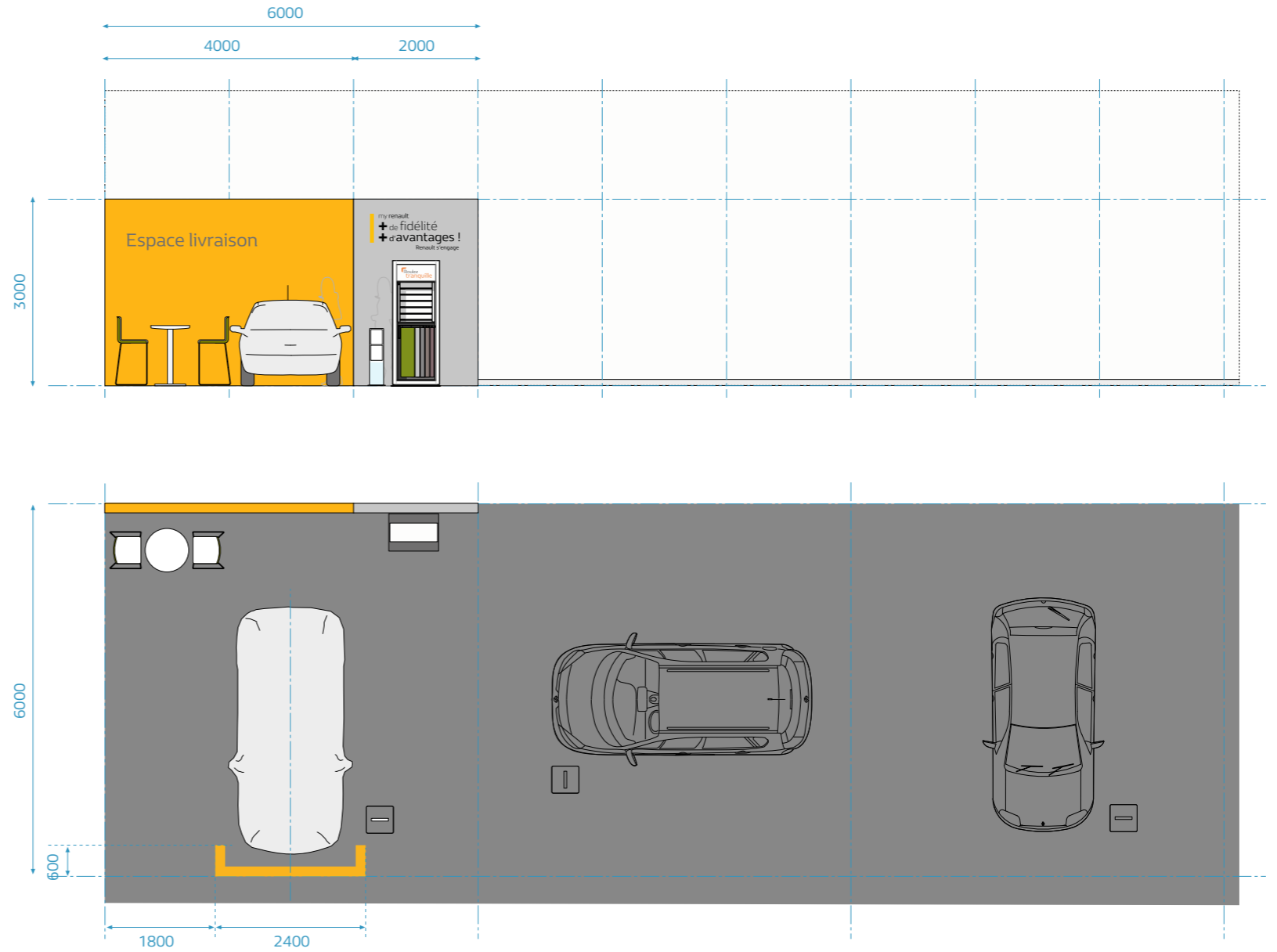

# 6 m configuration with 1 vehicle

## Installation at a 45° angle.

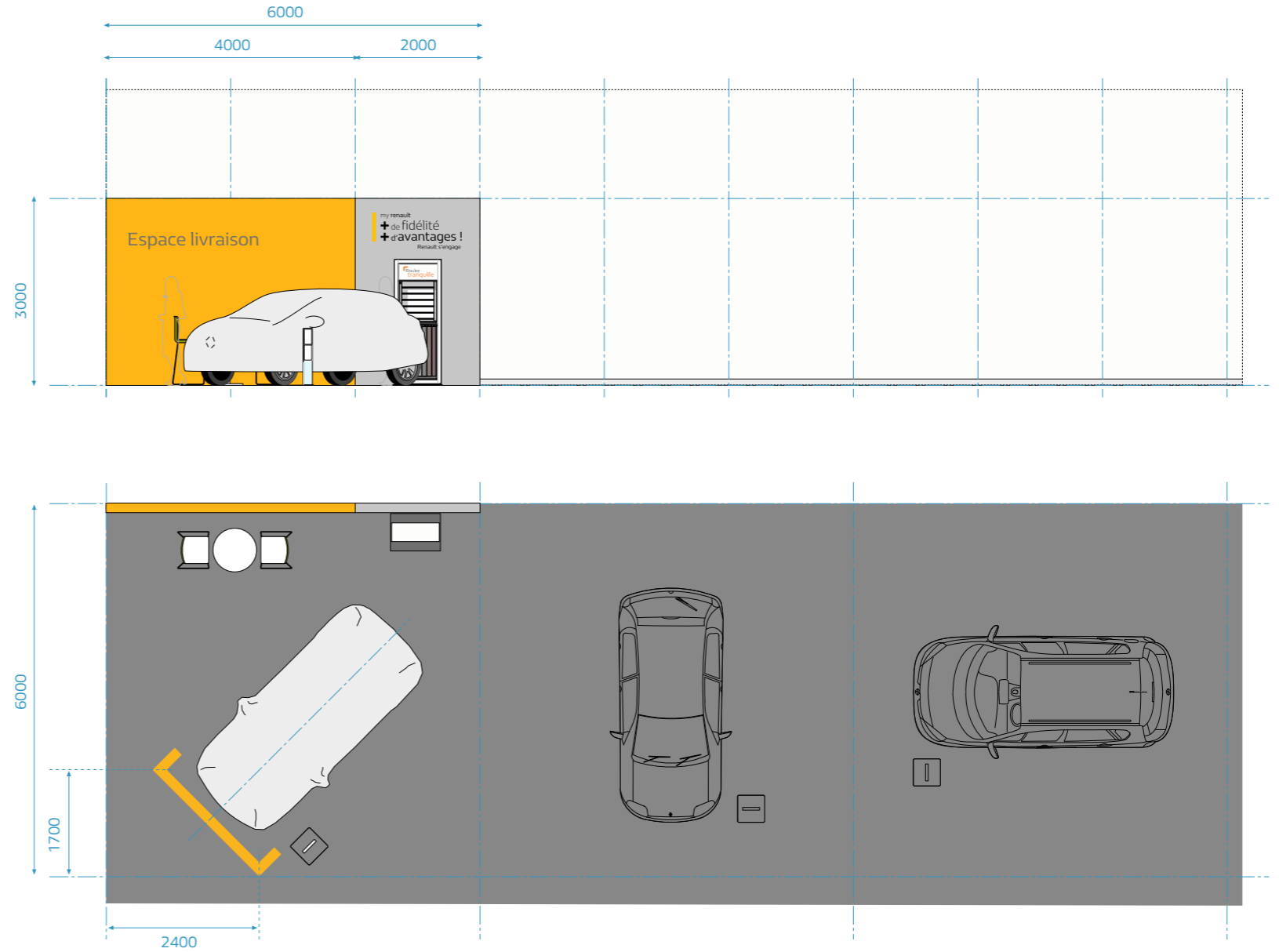

# 8 m configuration with 1 vehicle

## In-line installation of the vehicle

### Variant 1

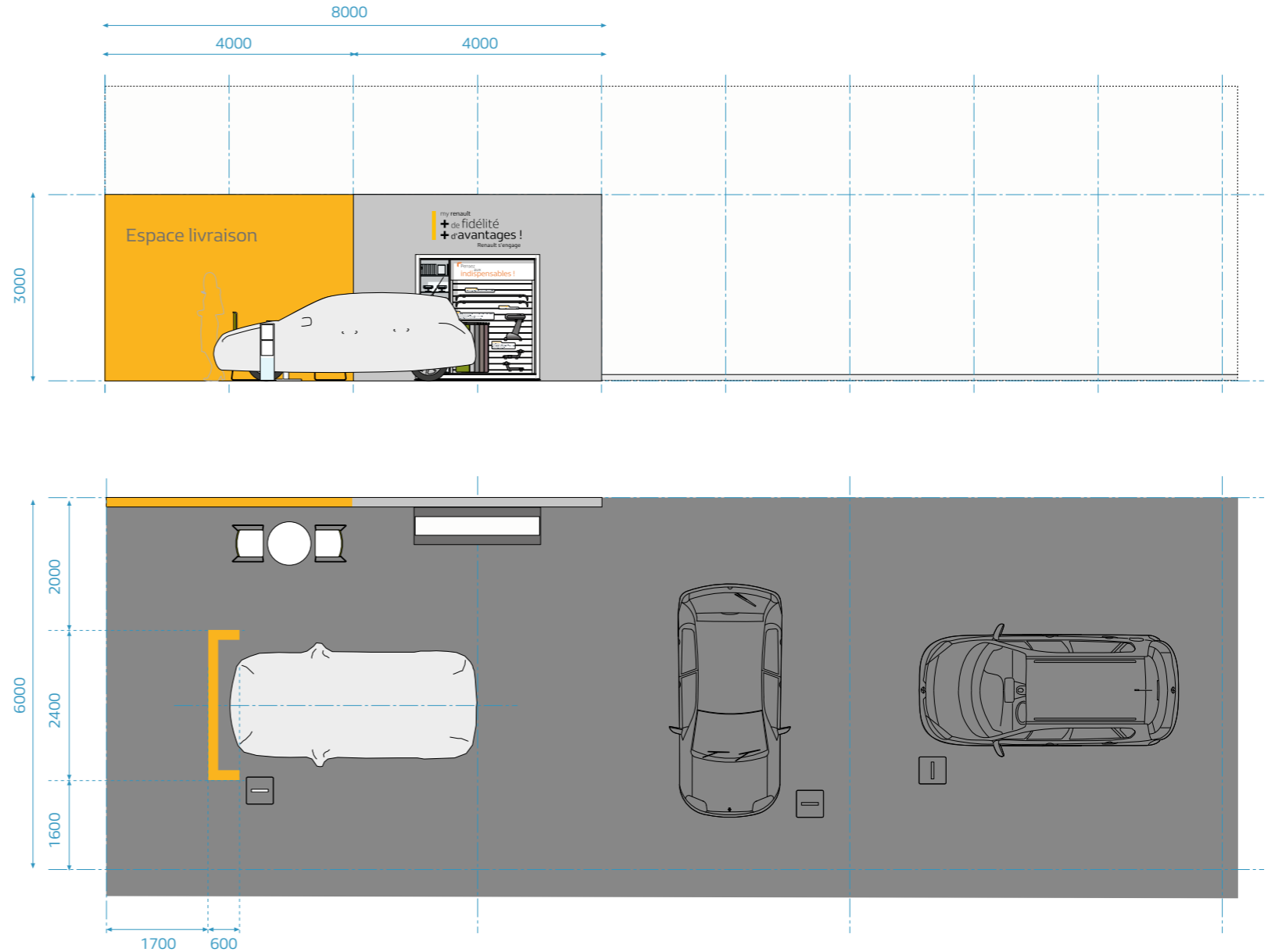

# 8 m configuration with 1 vehicle

## In-line installation of the vehicle

### Variant 2

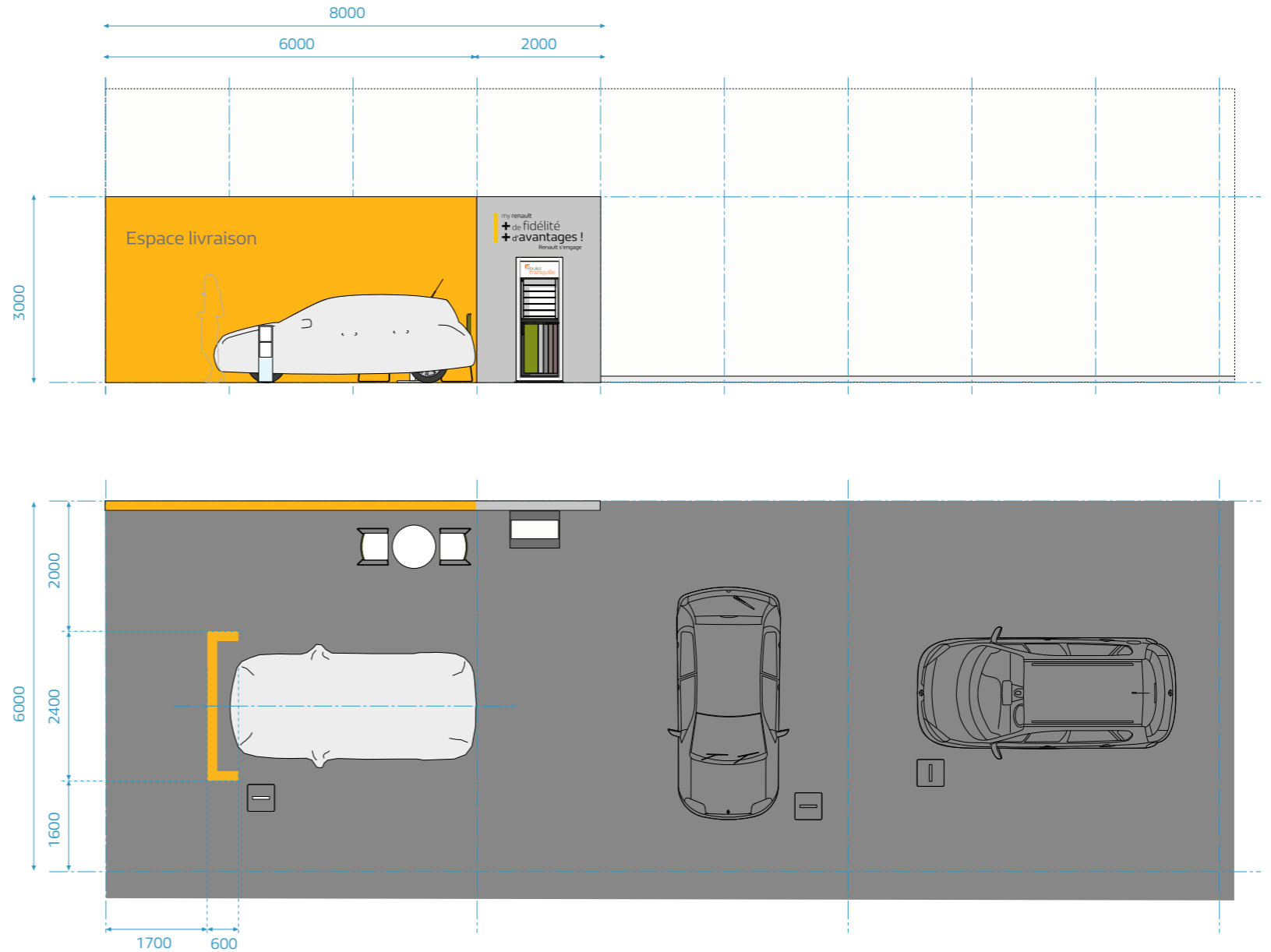

## 8 m configuration with 1 vehicle

### Perpendicular installation of the vehicle

#### Variant 1

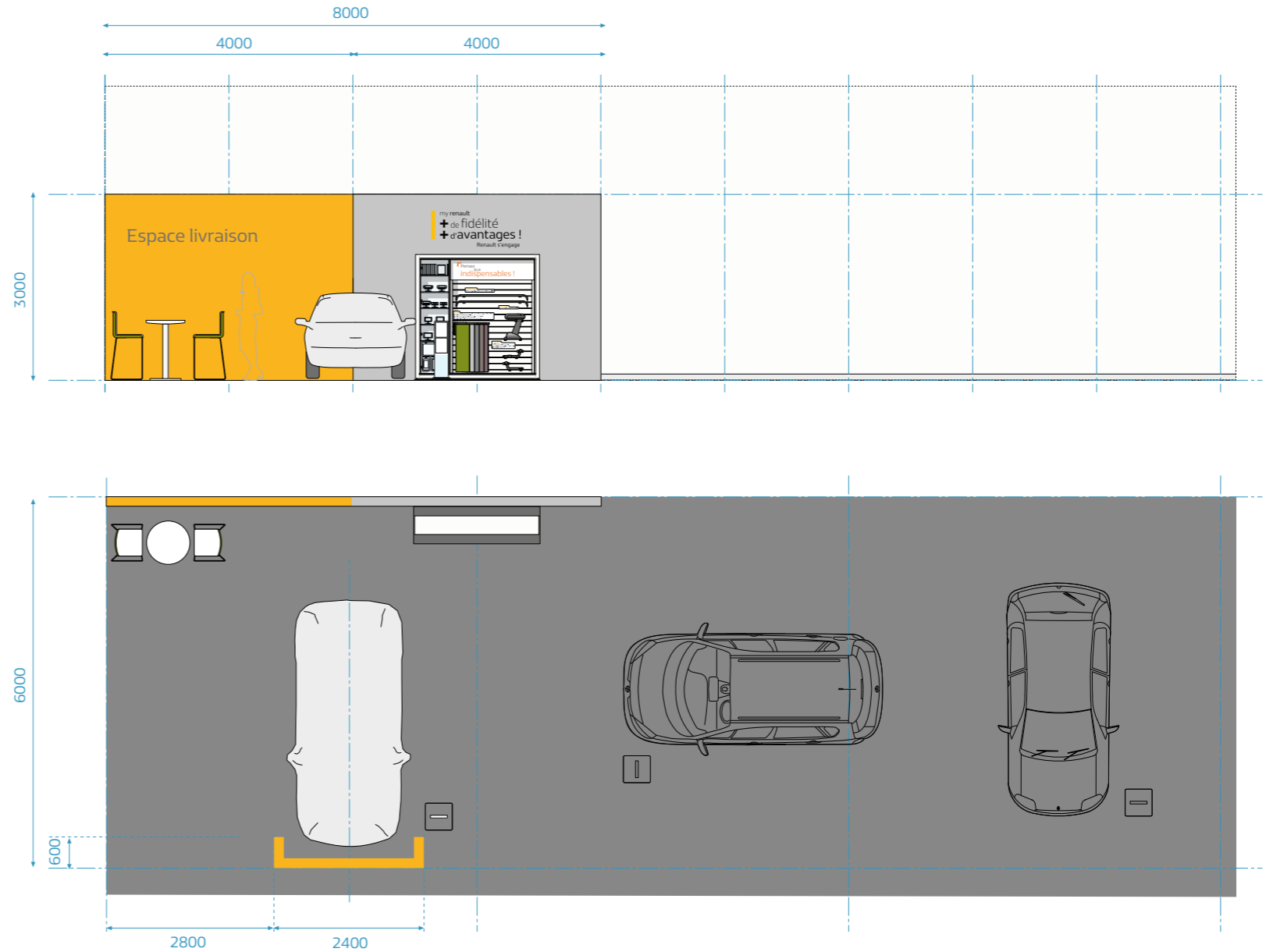



# 8 m configuration with 1 vehicle

## Perpendicular installation of the vehicle

### Variant 2

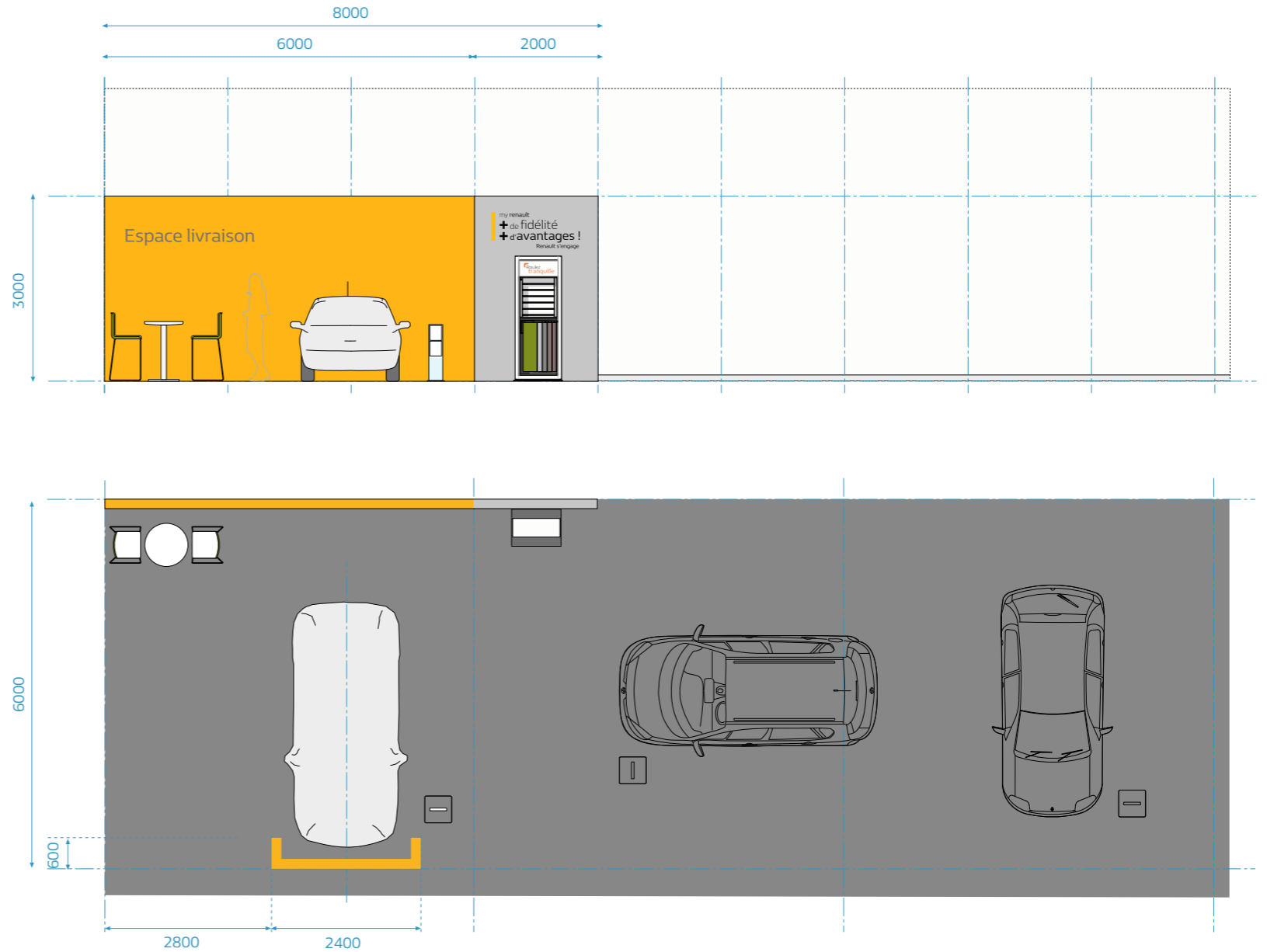

## 8 m configuration with 1 vehicle

### Installation of the vehicle at a 45° angle

#### Variant 1

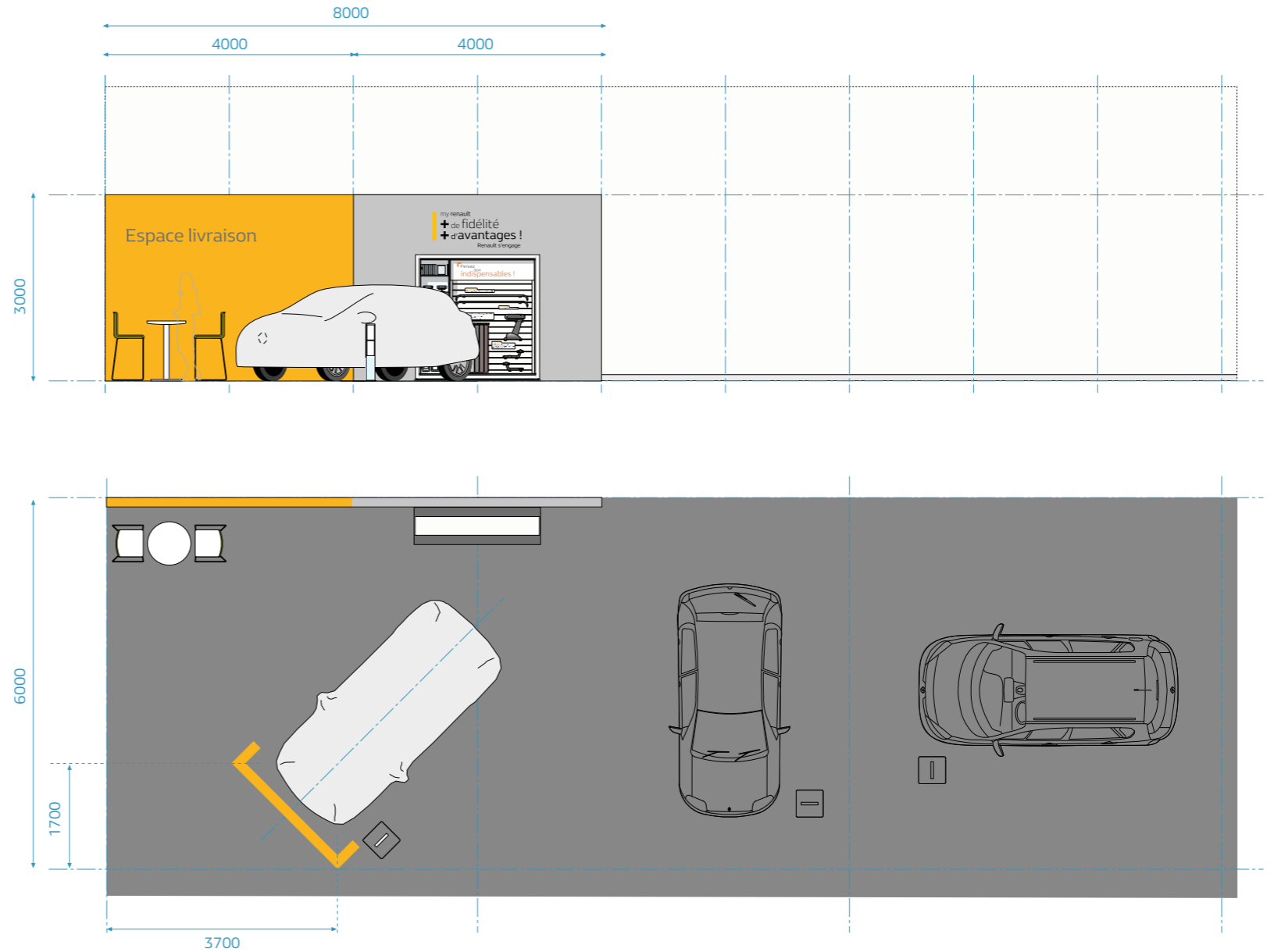

## 8 m configuration with 1 vehicle

### Installation of the vehicle at a 45° angle

#### Variant 2

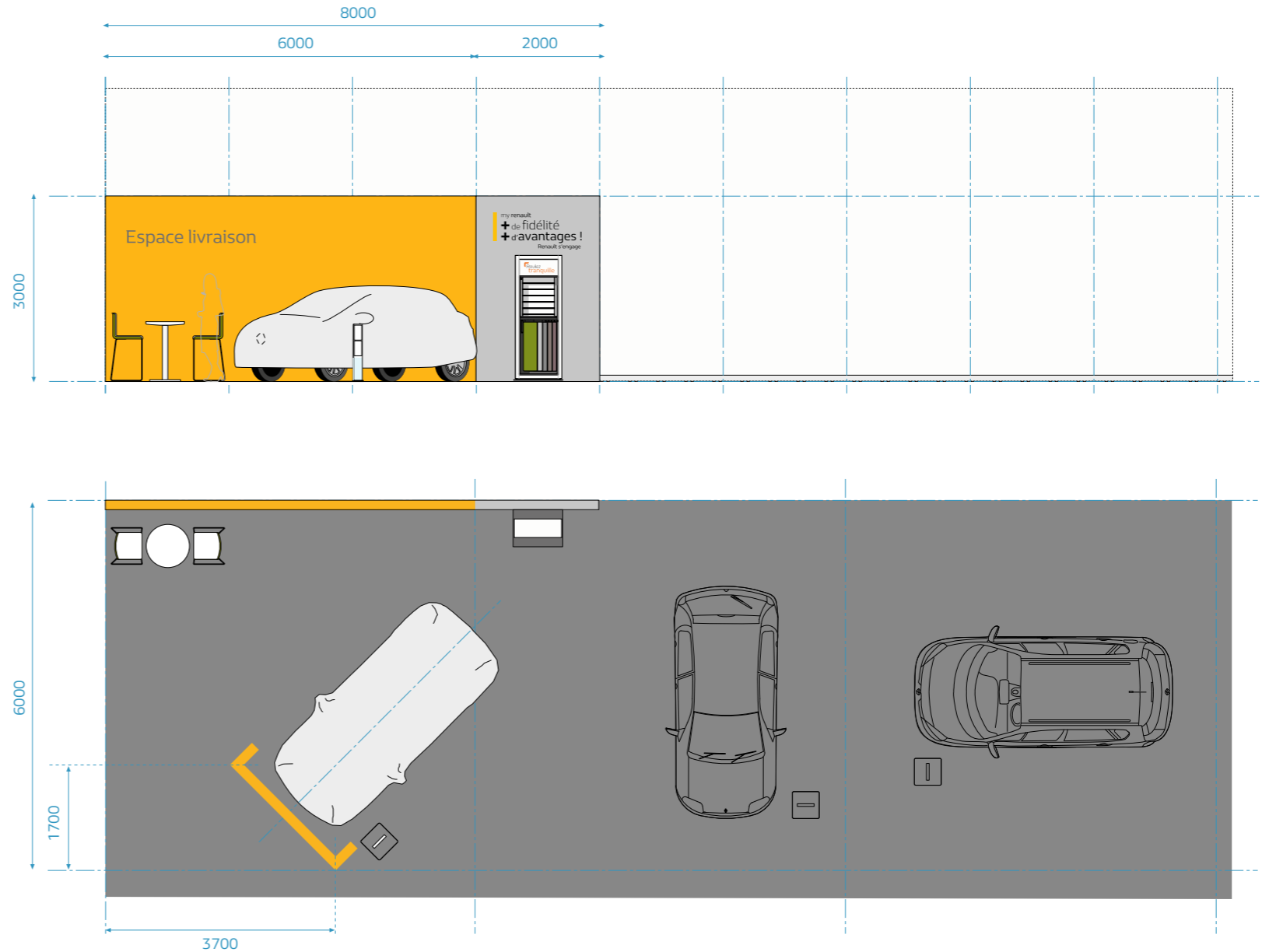

# 12 m configuration with 2 vehicles

## In-line installation of vehicles

### Variant 1

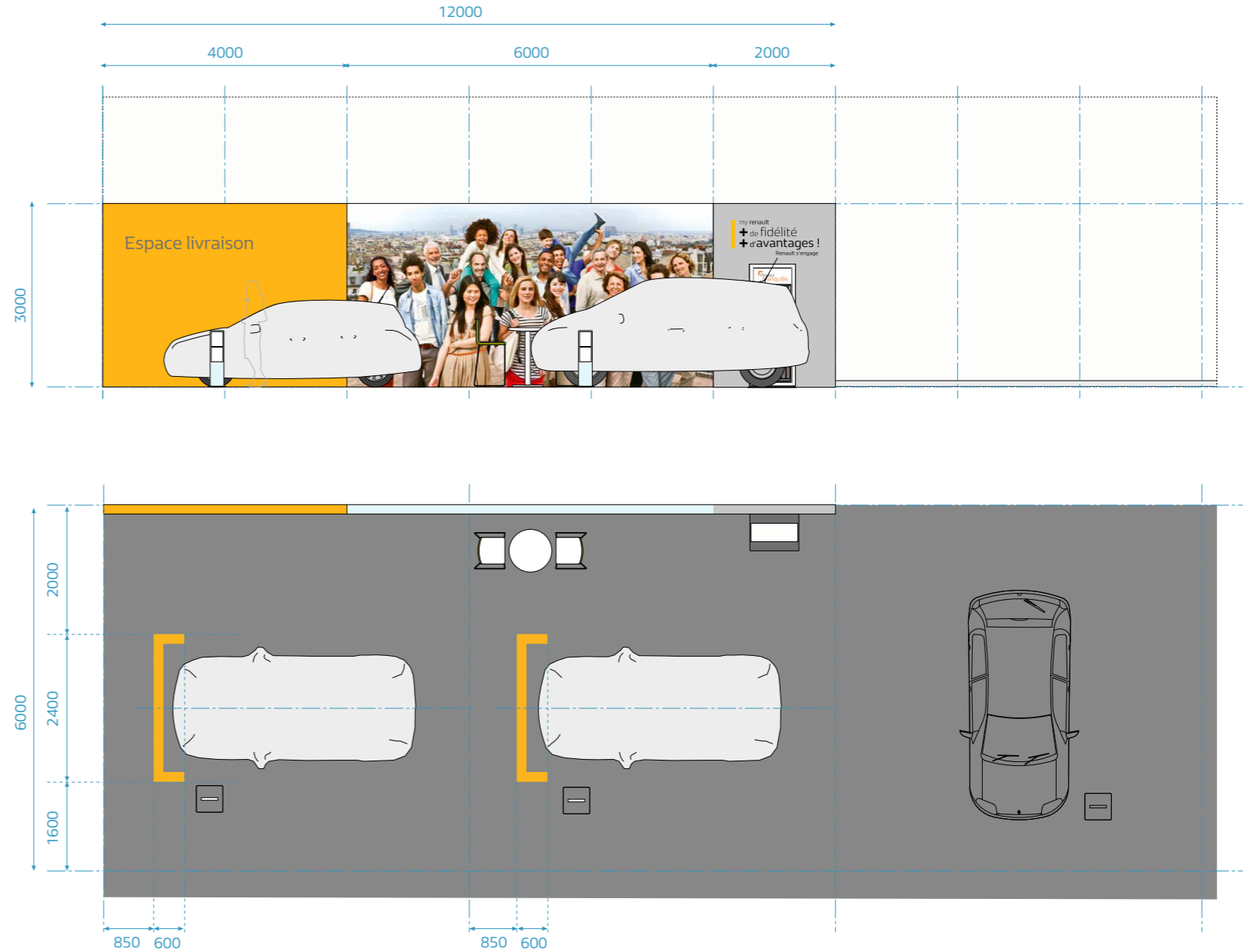

# 12 m configuration with 2 vehicles

## In-line installation of vehicles

### Variant 2

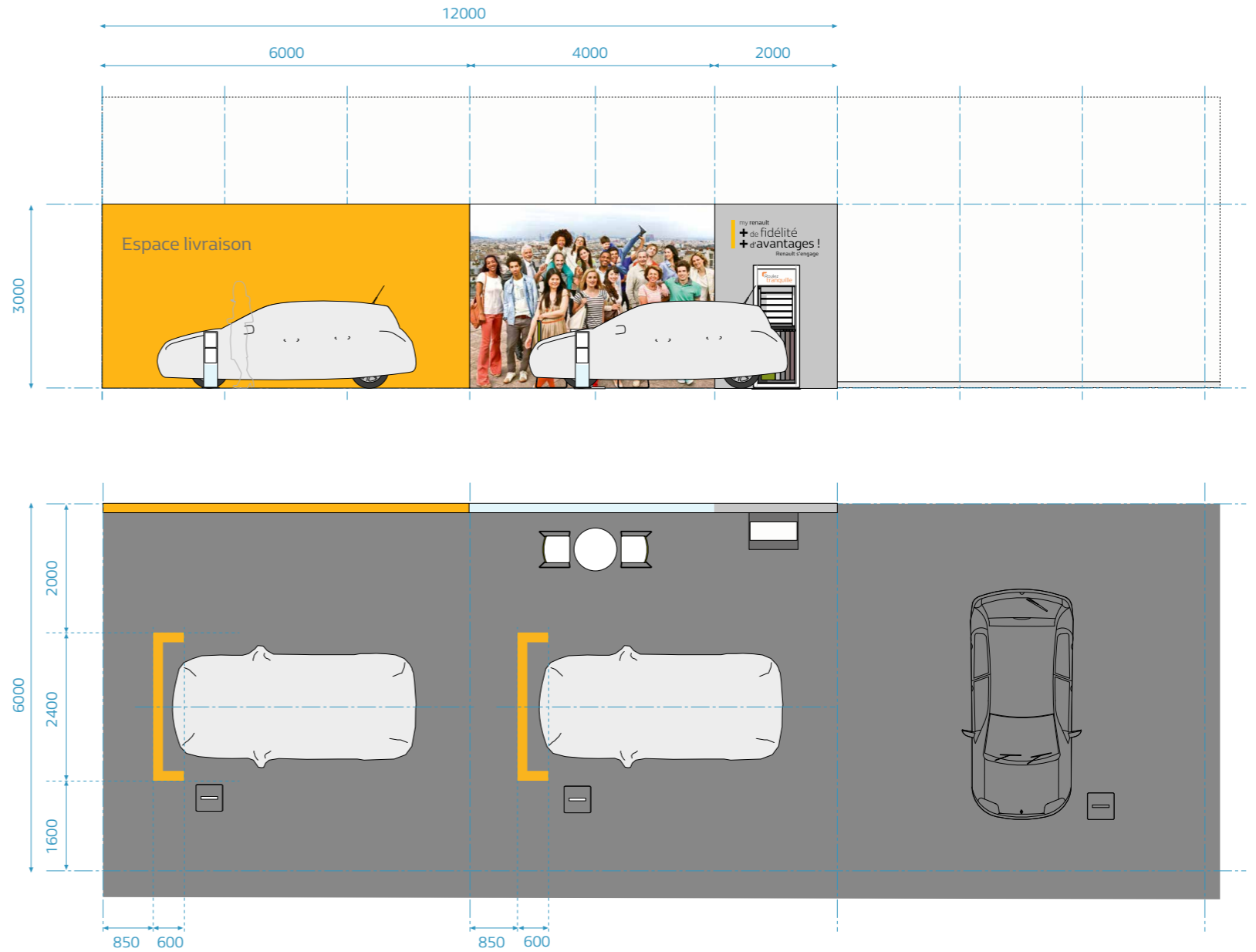

# 12 m configuration with 2 vehicles

## In-line installation of vehicles

### Variant 3

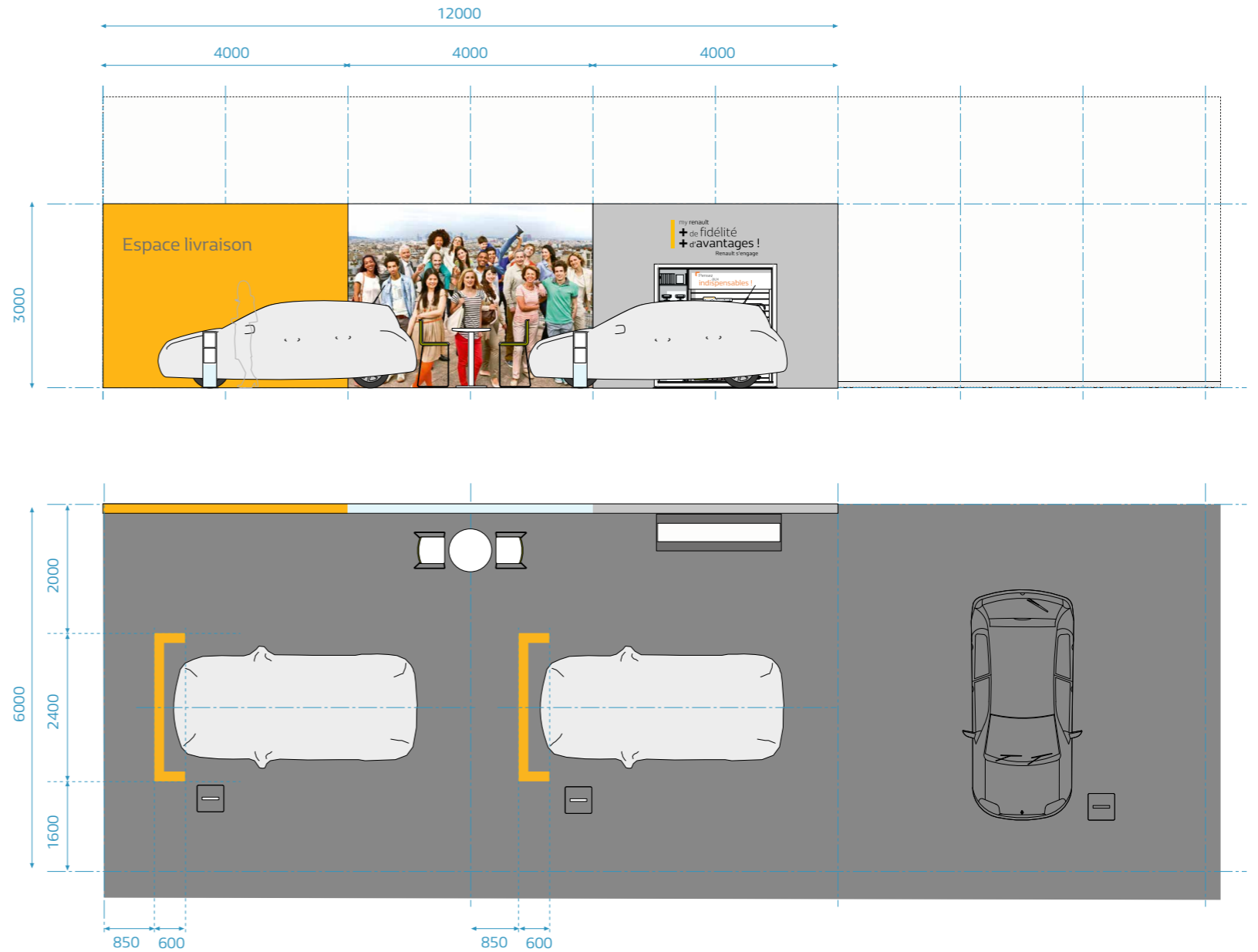

# 12 m configuration with 2 vehicles

## In-line installation of vehicles

### Variant 4

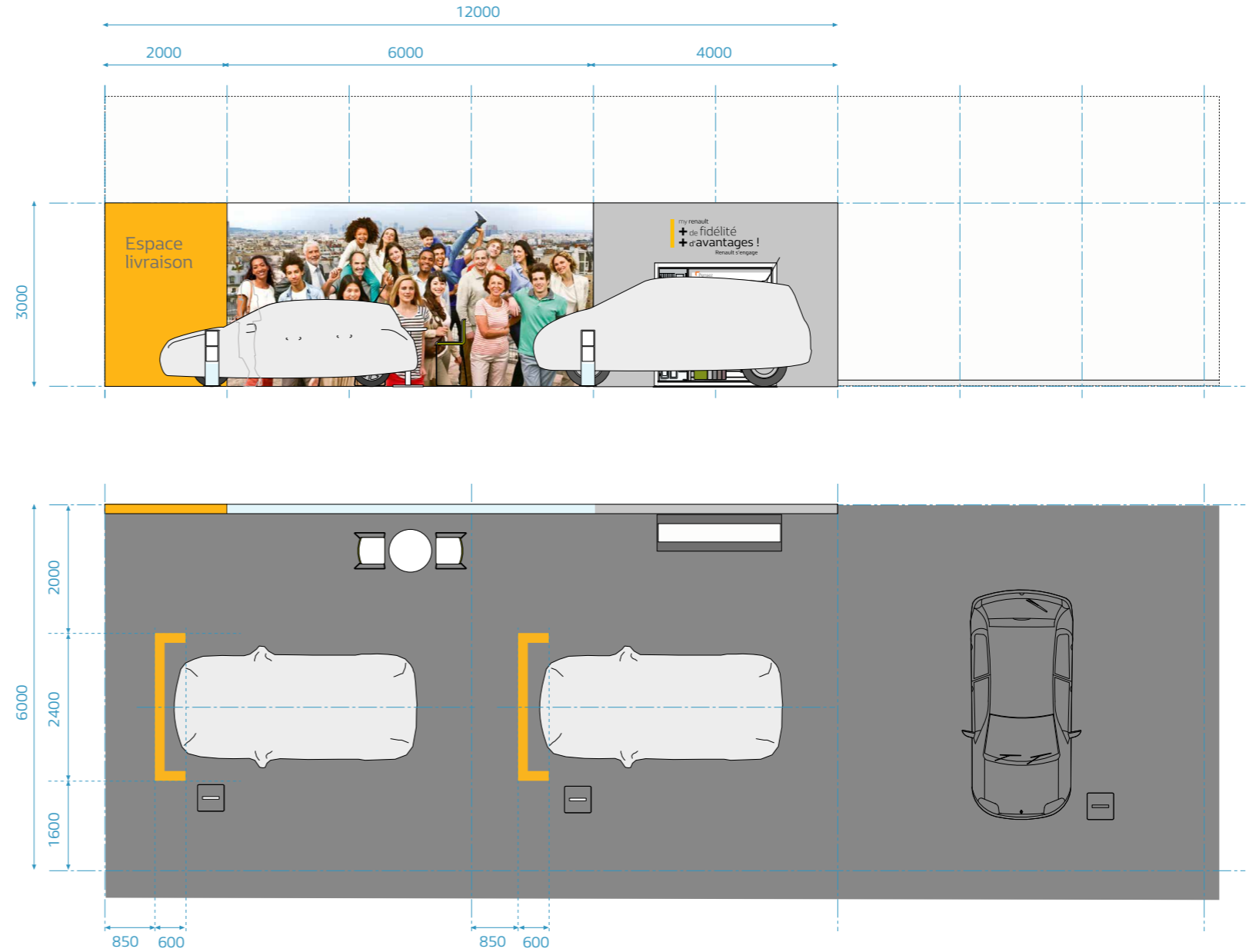

# 12 m configuration with 2 vehicles

## Perpendicular installation of vehicles

### Variant 1

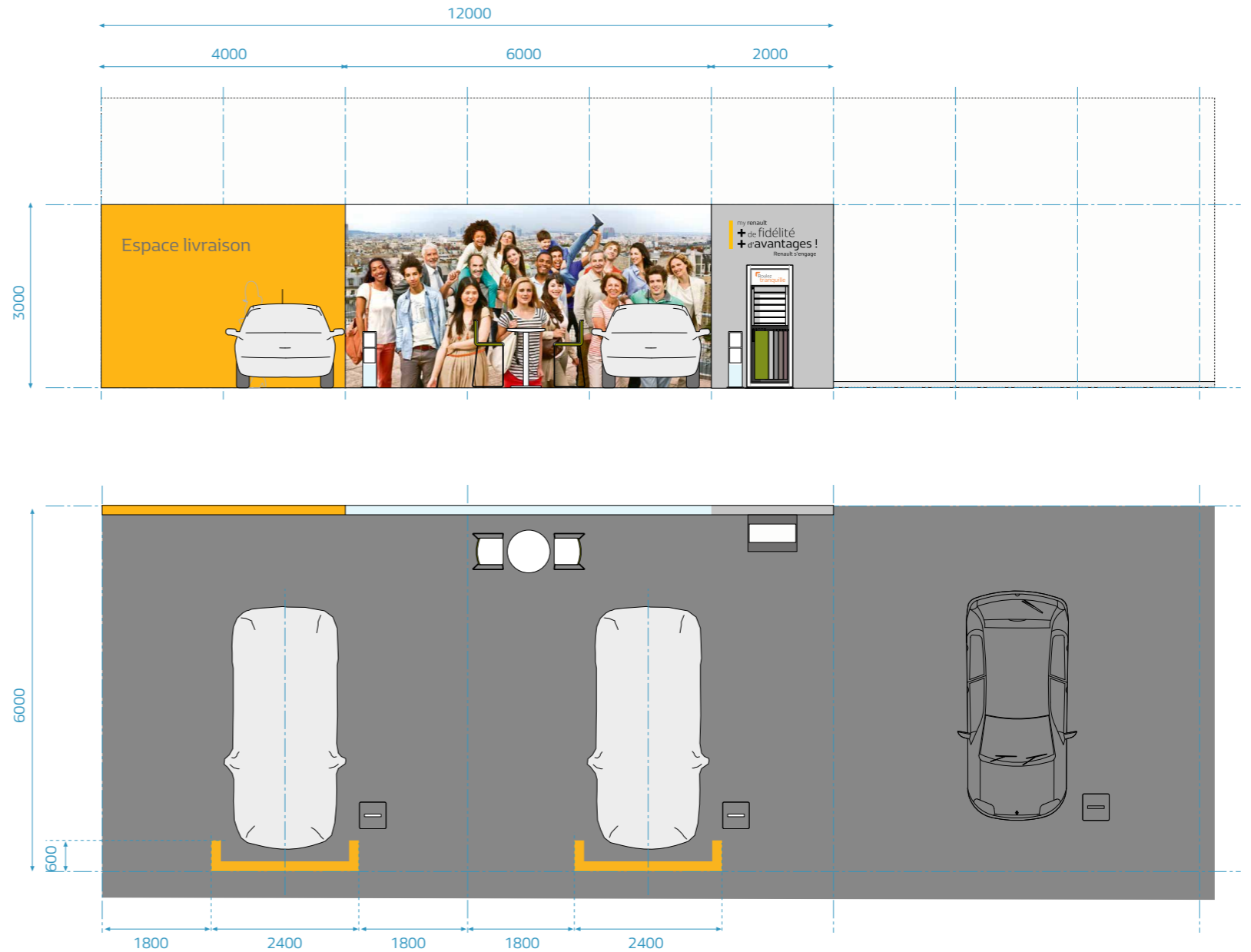



# 12 m configuration with 2 vehicles

## Perpendicular installation of vehicles

### Variant 2

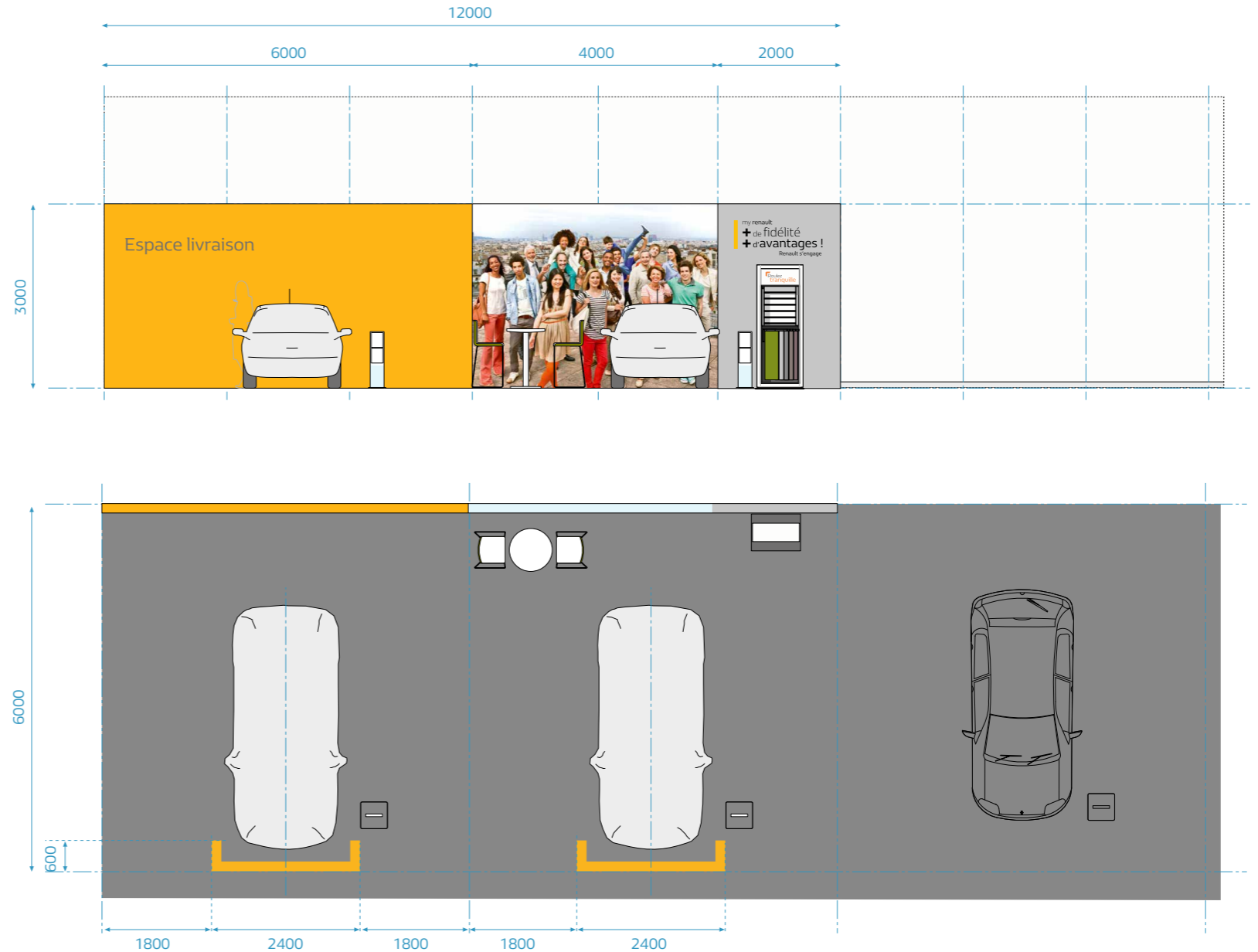

# 12 m configuration with 2 vehicles

## Perpendicular installation of vehicles

### Variant 3

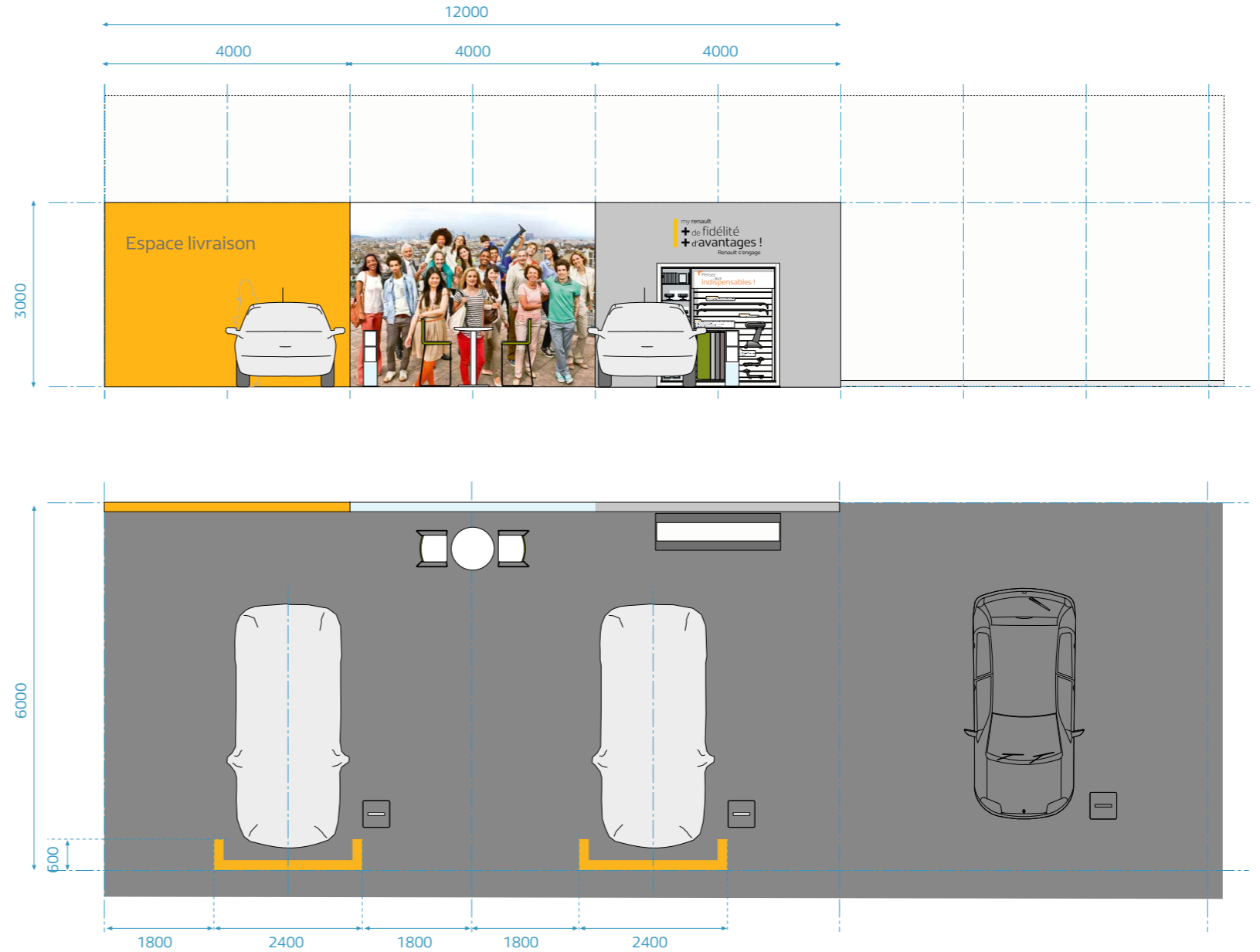

# 12 m configuration with 2 vehicles

## Perpendicular installation of vehicles

### Variant 4

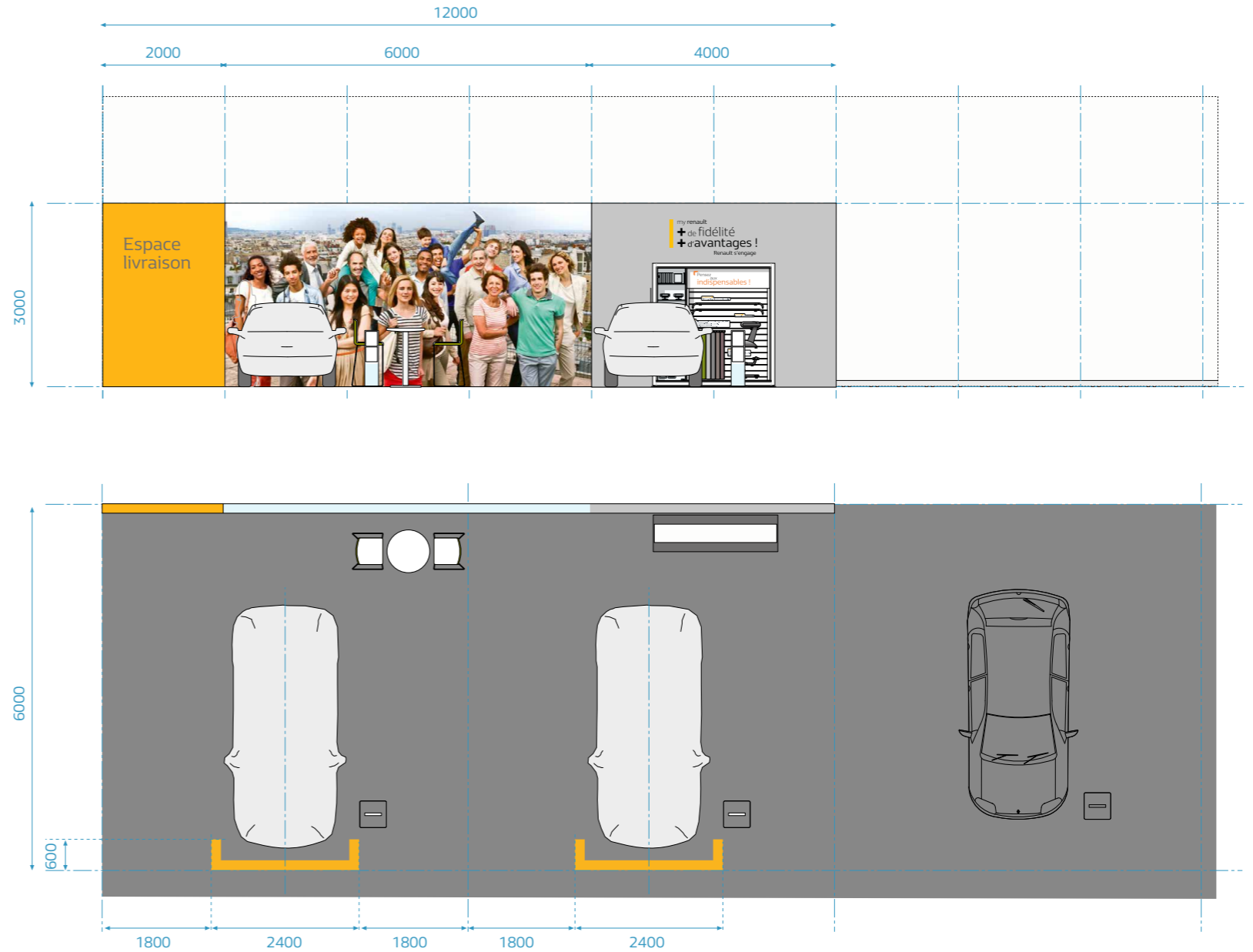

# 12 m configuration with 2 vehicles

## Installation of vehicles at a 45° angle

### Variant 1

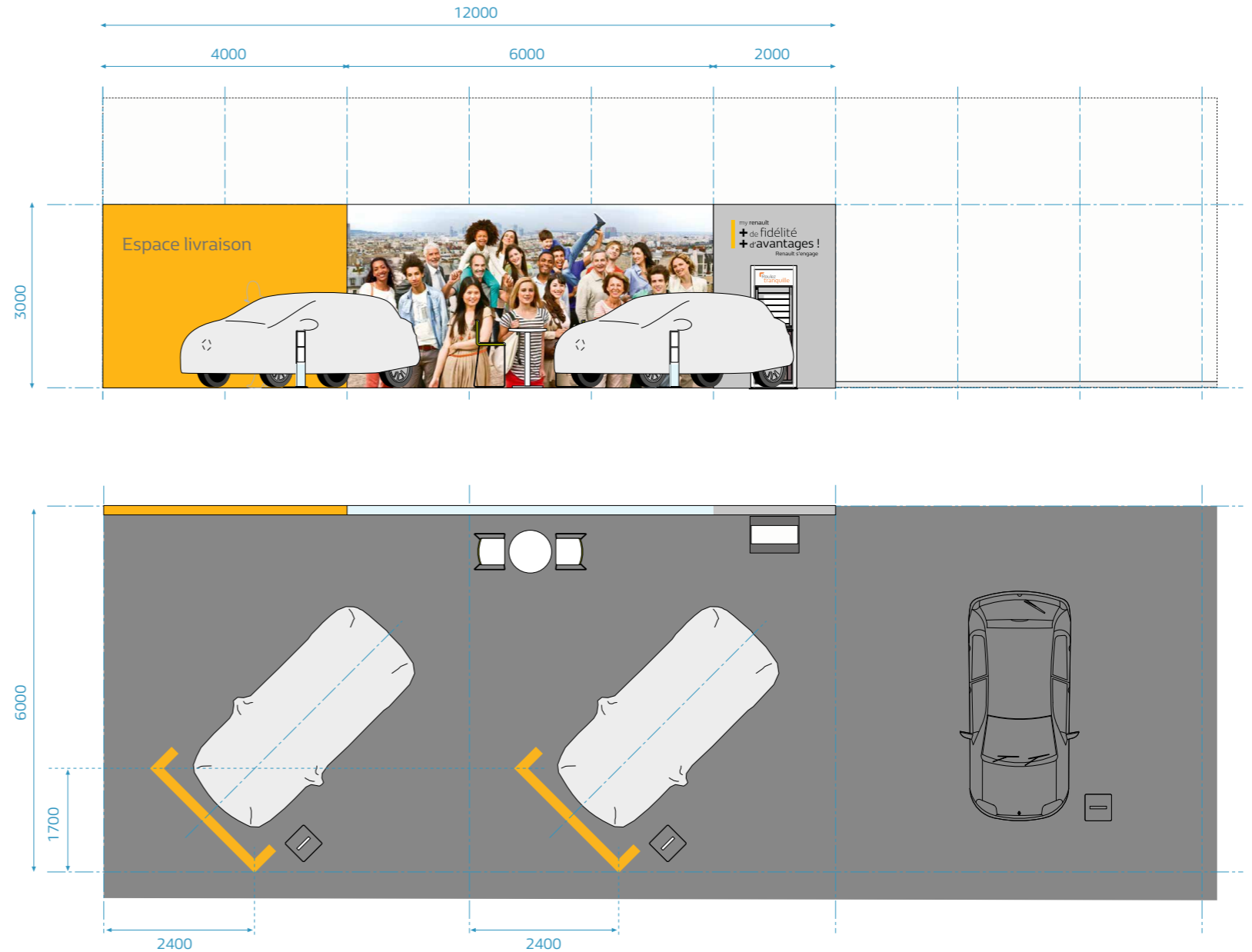

# 12 m configuration with 2 vehicles

## Installation of vehicles at a 45° angle

### Variant 2

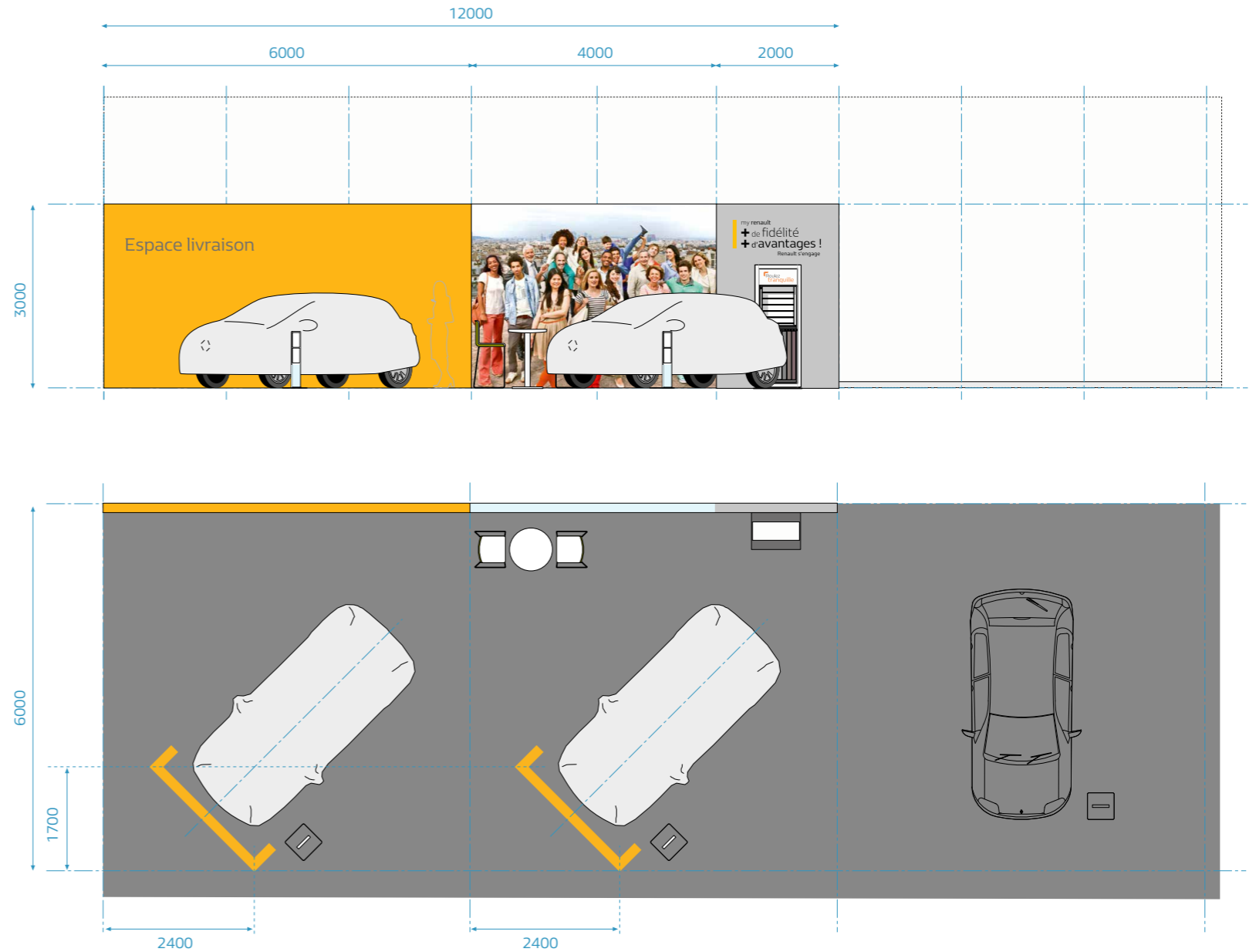

# 12 m configuration with 2 vehicles

## Installation of vehicles at a 45° angle

### Variant 3

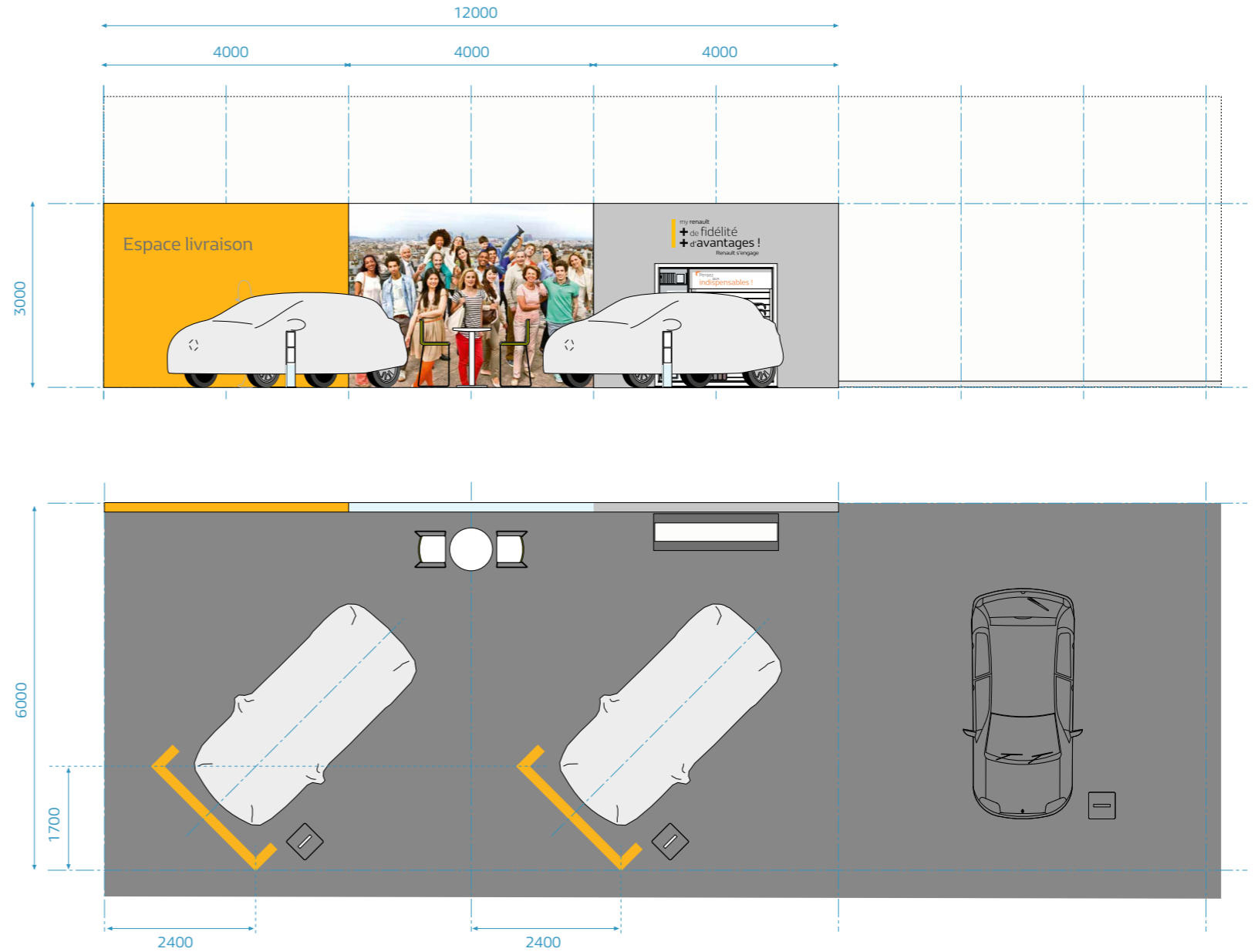

# 12 m configuration with 2 vehicles

## Installation of vehicles at a 45° angle

### Variant 4

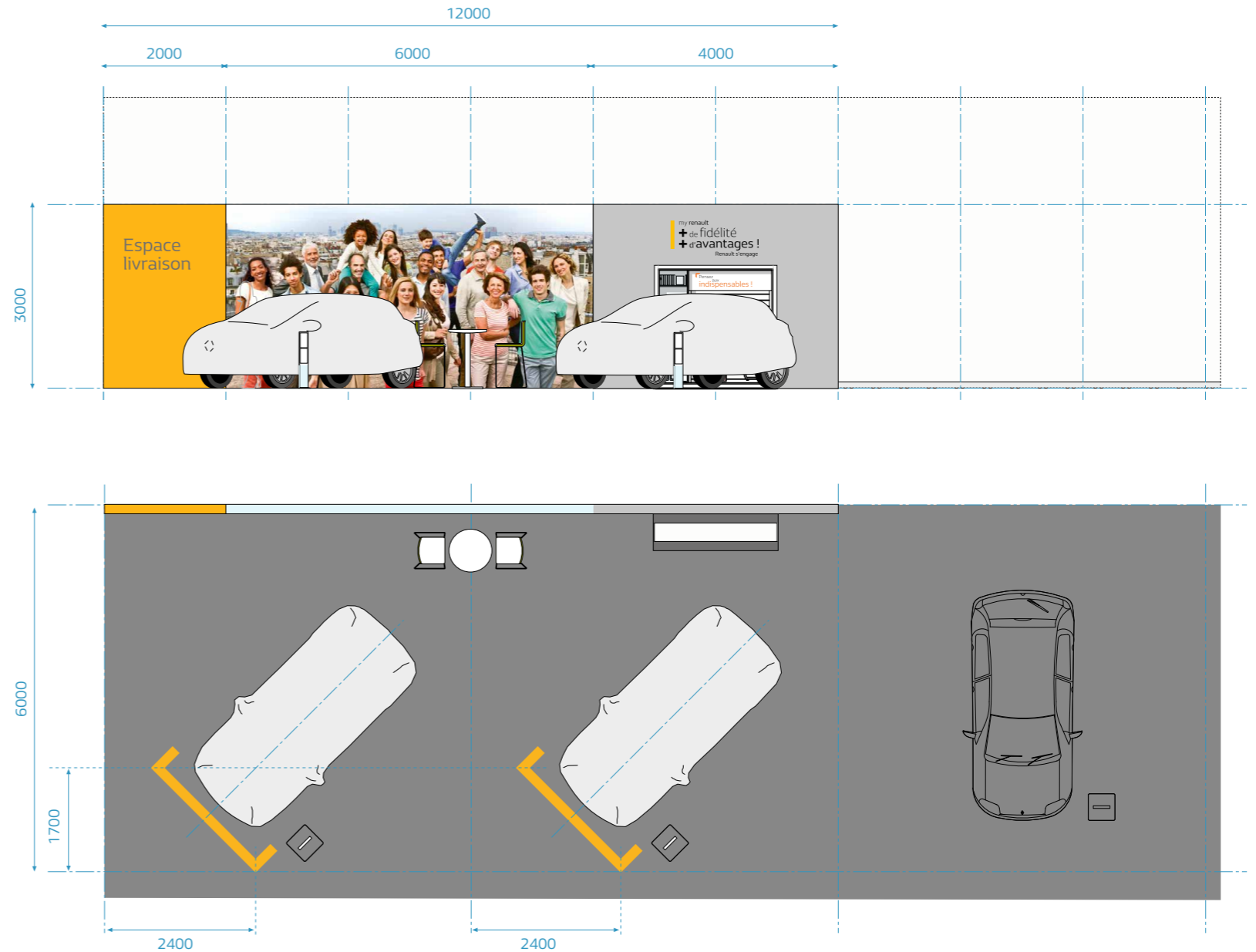

# 18 m configuration with 3 vehicles

## In-line installation of vehicles

### Variant 1

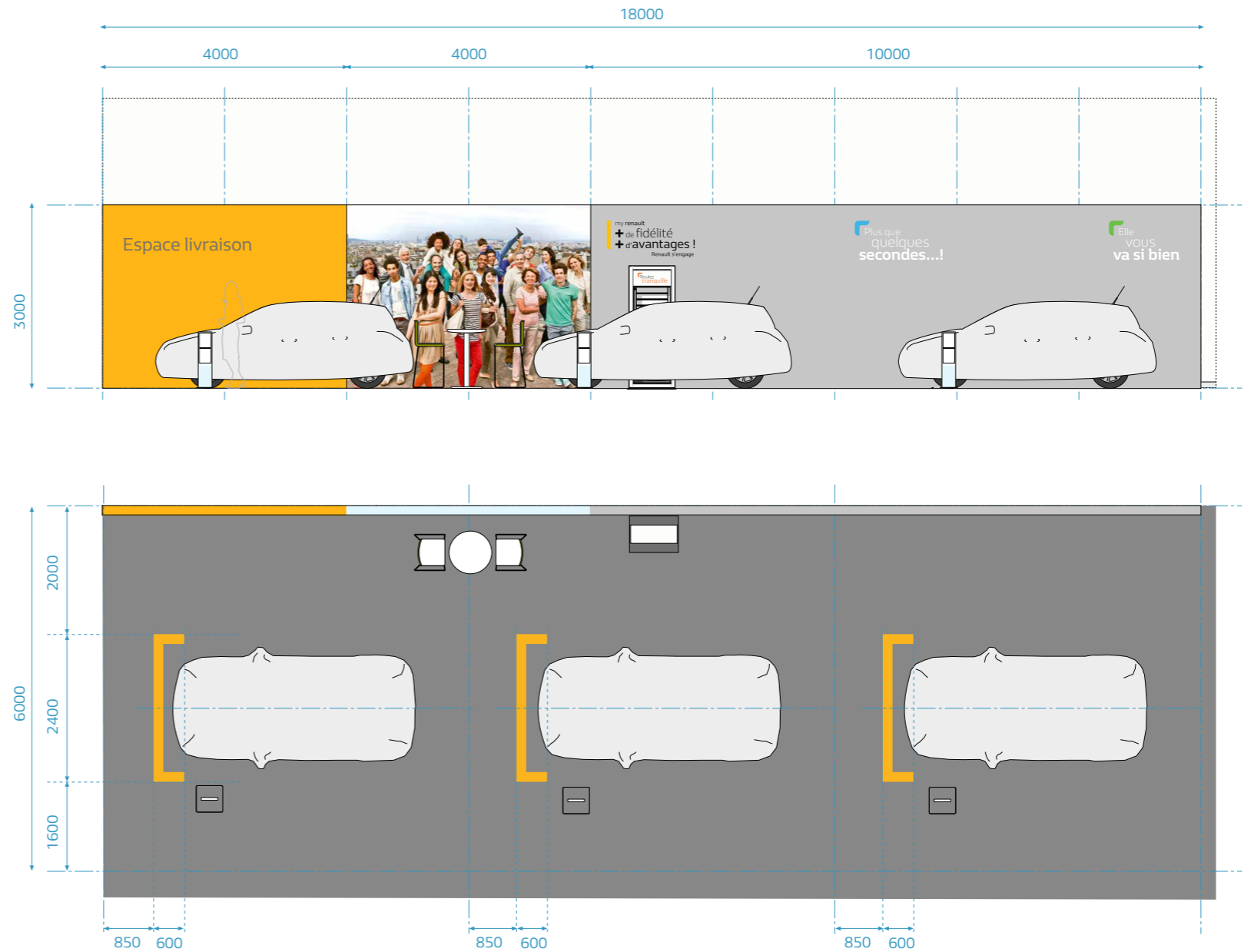



# 18 m configuration with 3 vehicles

## In-line installation of vehicles

### Variant 2

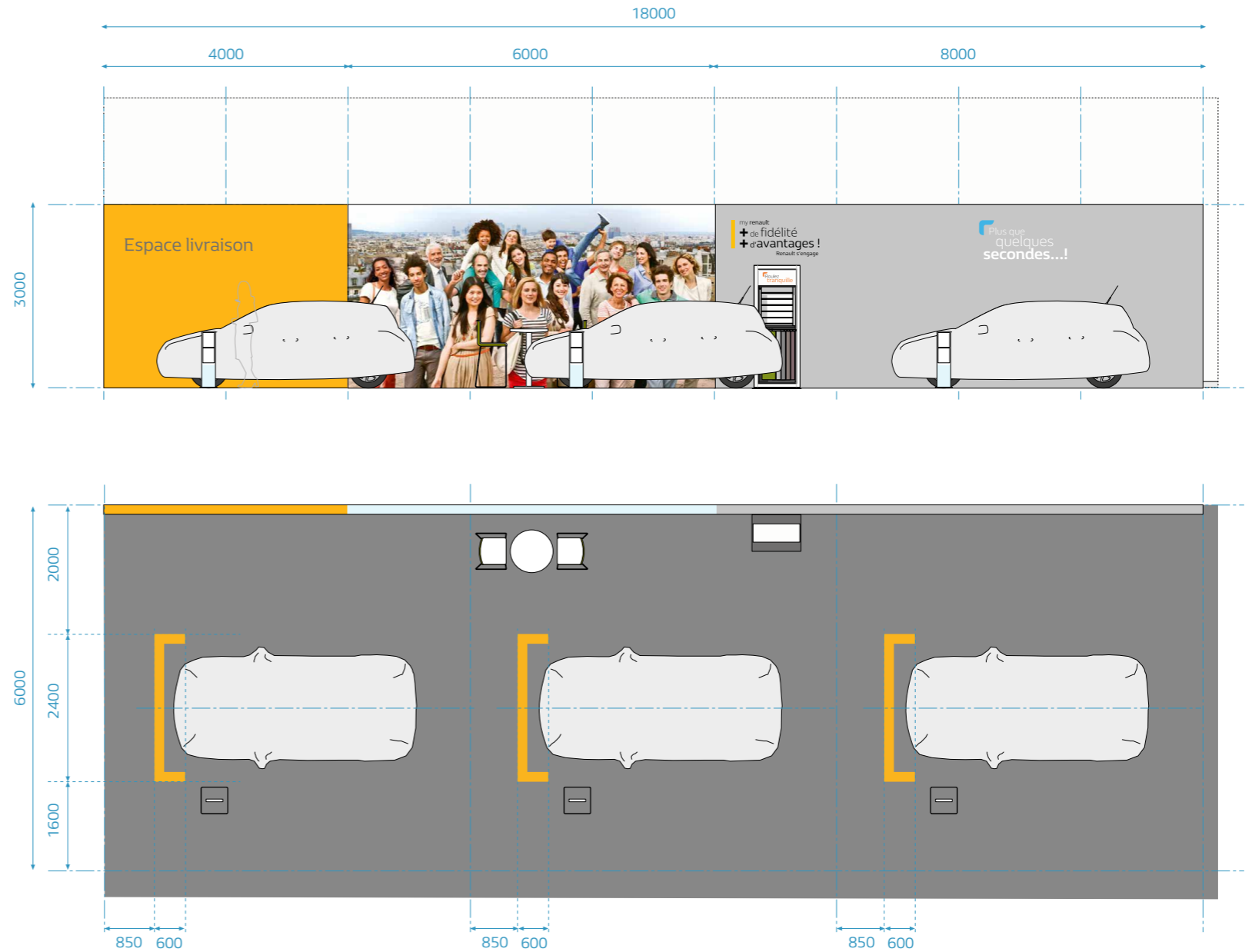

# 18 m configuration with 3 vehicles

## In-line installation of vehicles

### Variant 3

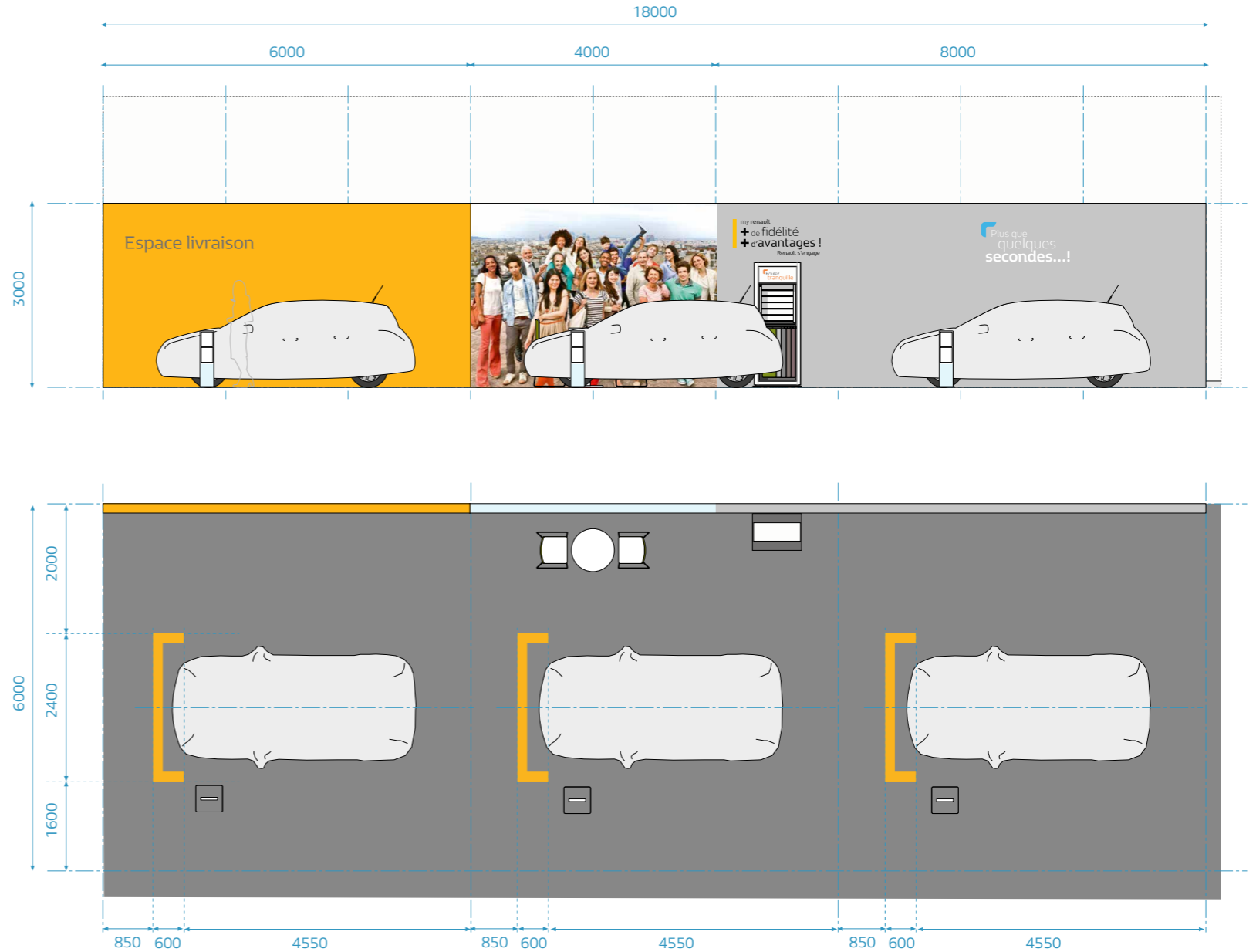

# 18 m configuration with 3 vehicles

## In-line installation of vehicles

### Variant 4

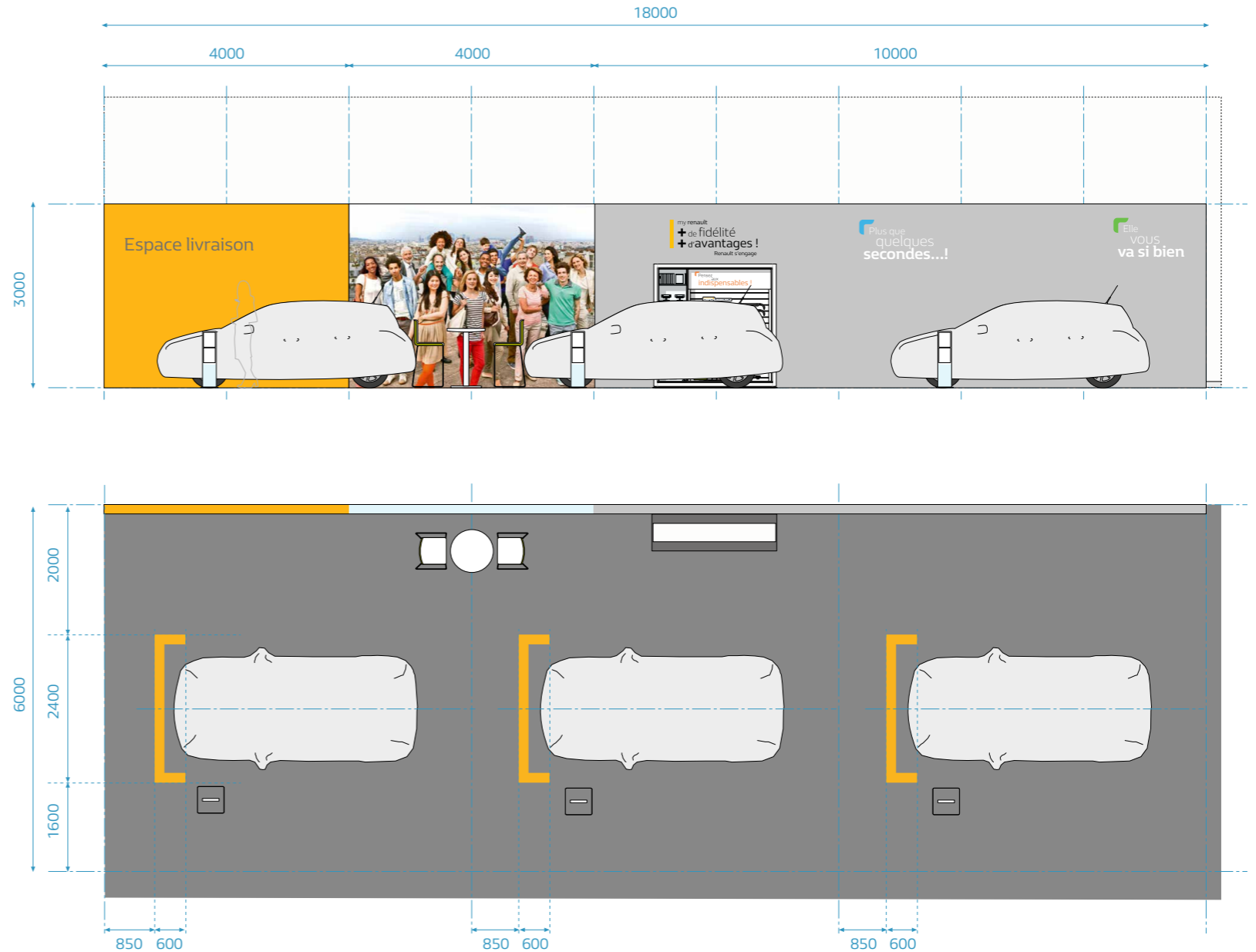

# 18 m configuration with 3 vehicles

## In-line installation of vehicles

### Variant 5

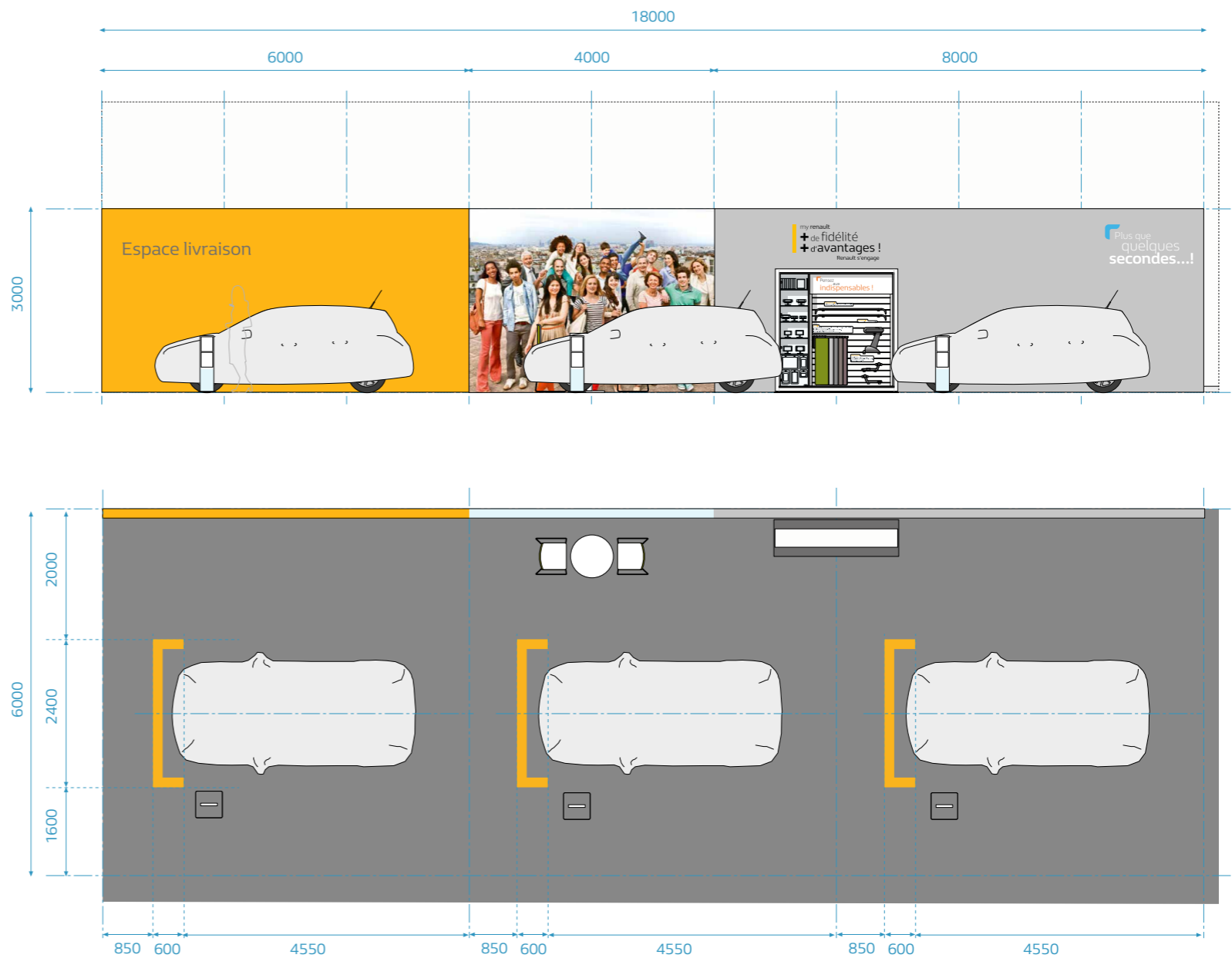

# 18 m configuration with 3 vehicles

## In-line installation of vehicles

### Variant 6

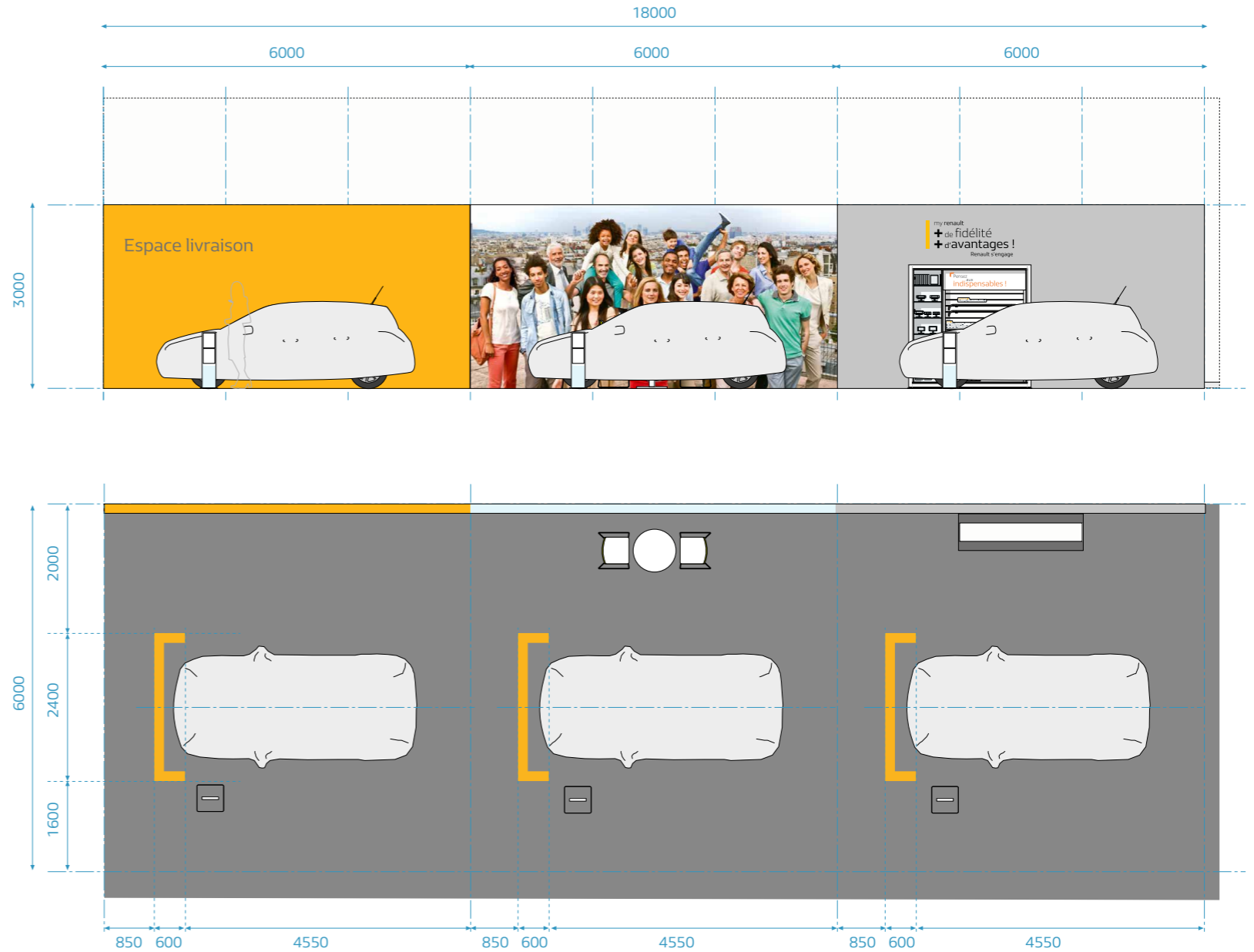



# 18 m configuration with 3 vehicles

## Perpendicular installation of vehicles

### Variant 2

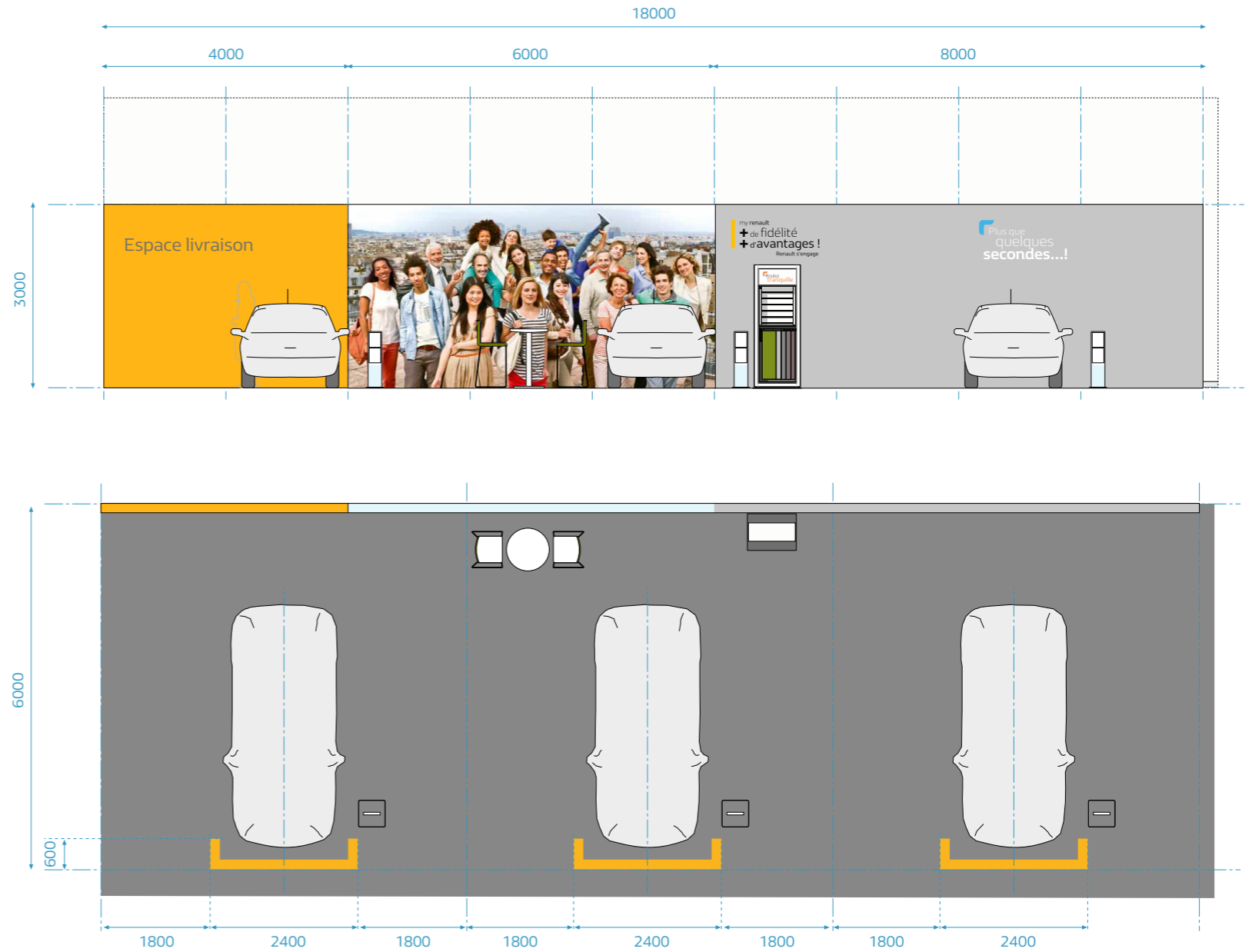

# 18 m configuration with 3 vehicles

## Perpendicular installation of vehicles

### Variant 3

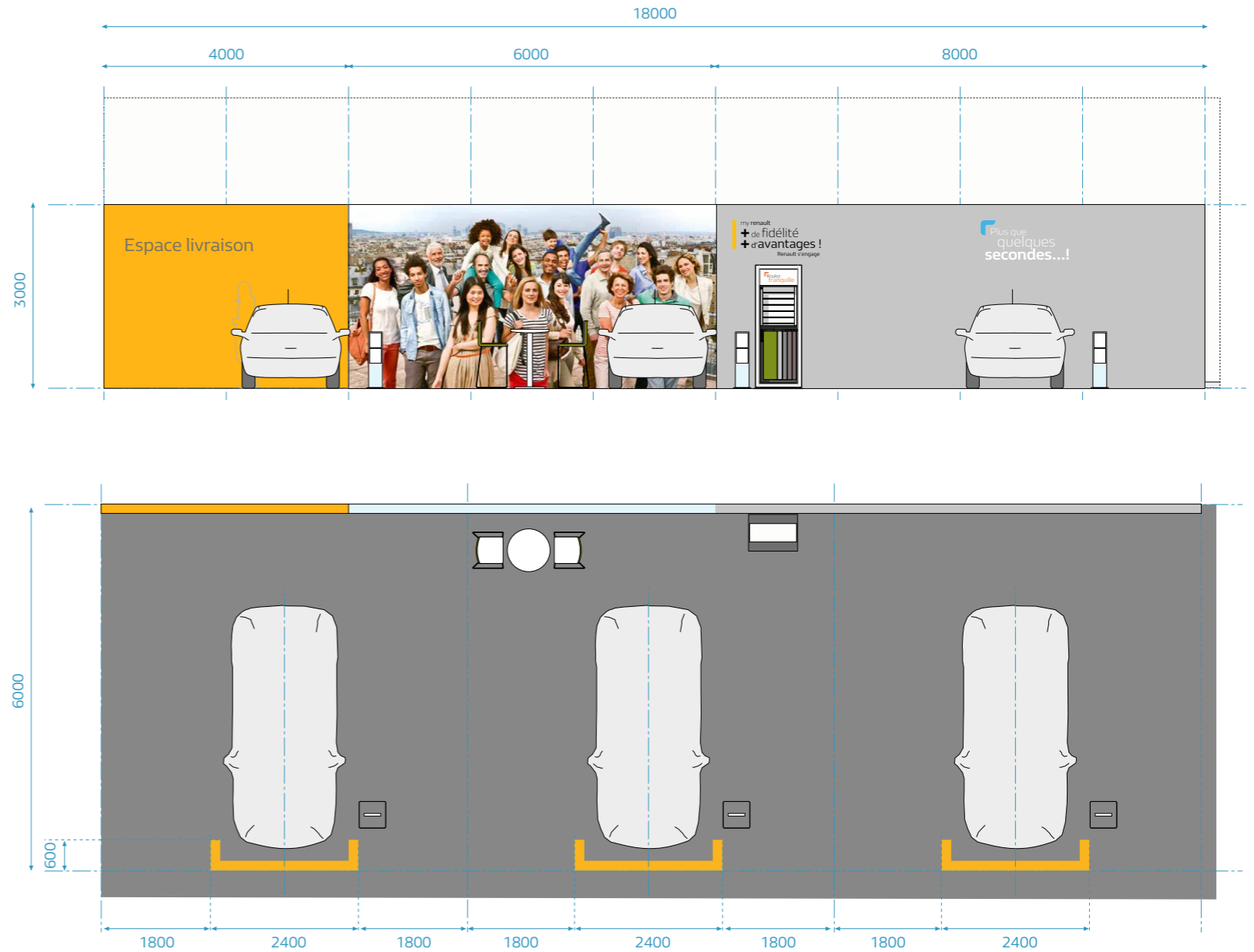



# 18 m configuration with 3 vehicles

## Perpendicular installation of vehicles

### Variant 4

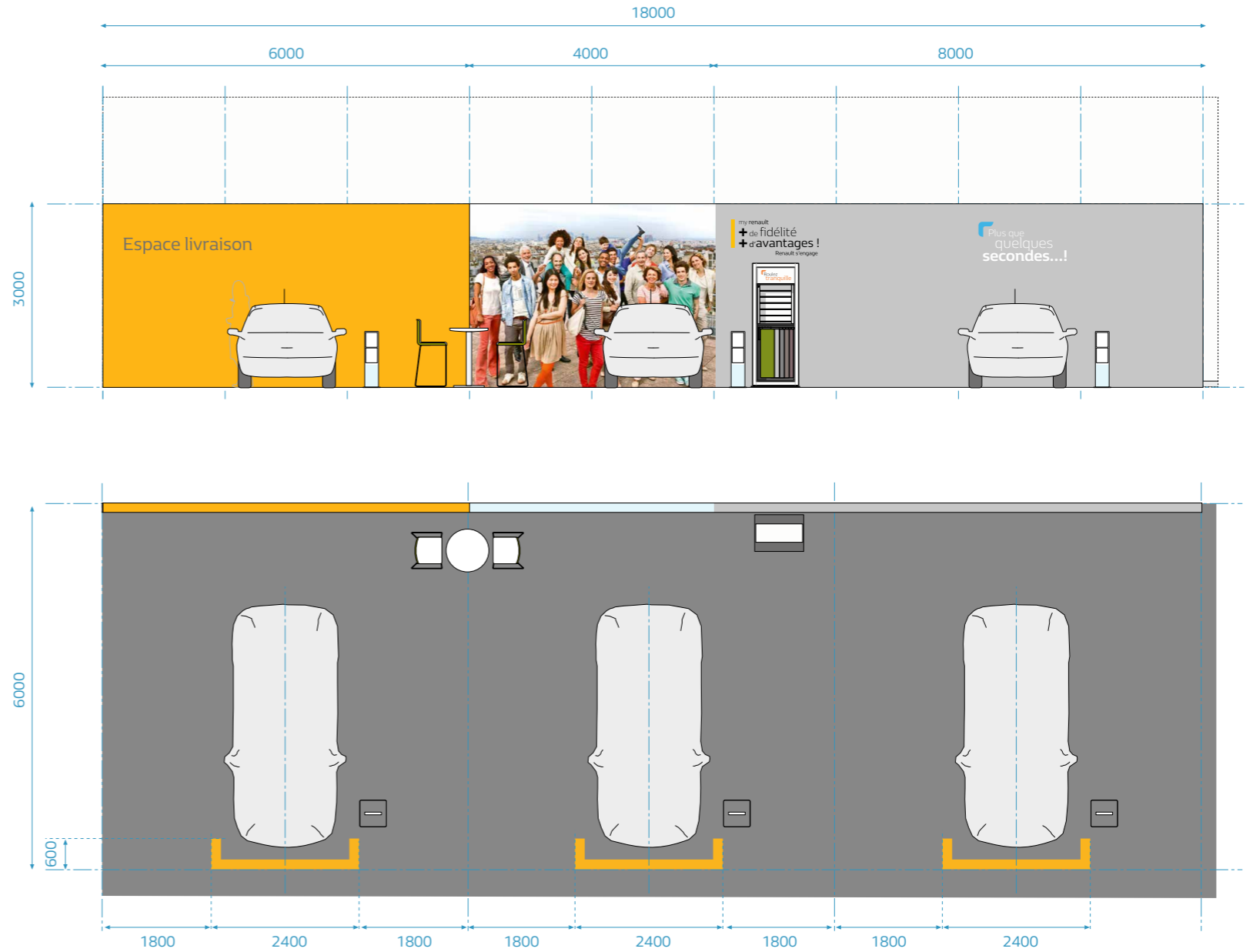

# 18 m configuration with 3 vehicles

## Perpendicular installation of vehicles

### Variant 5

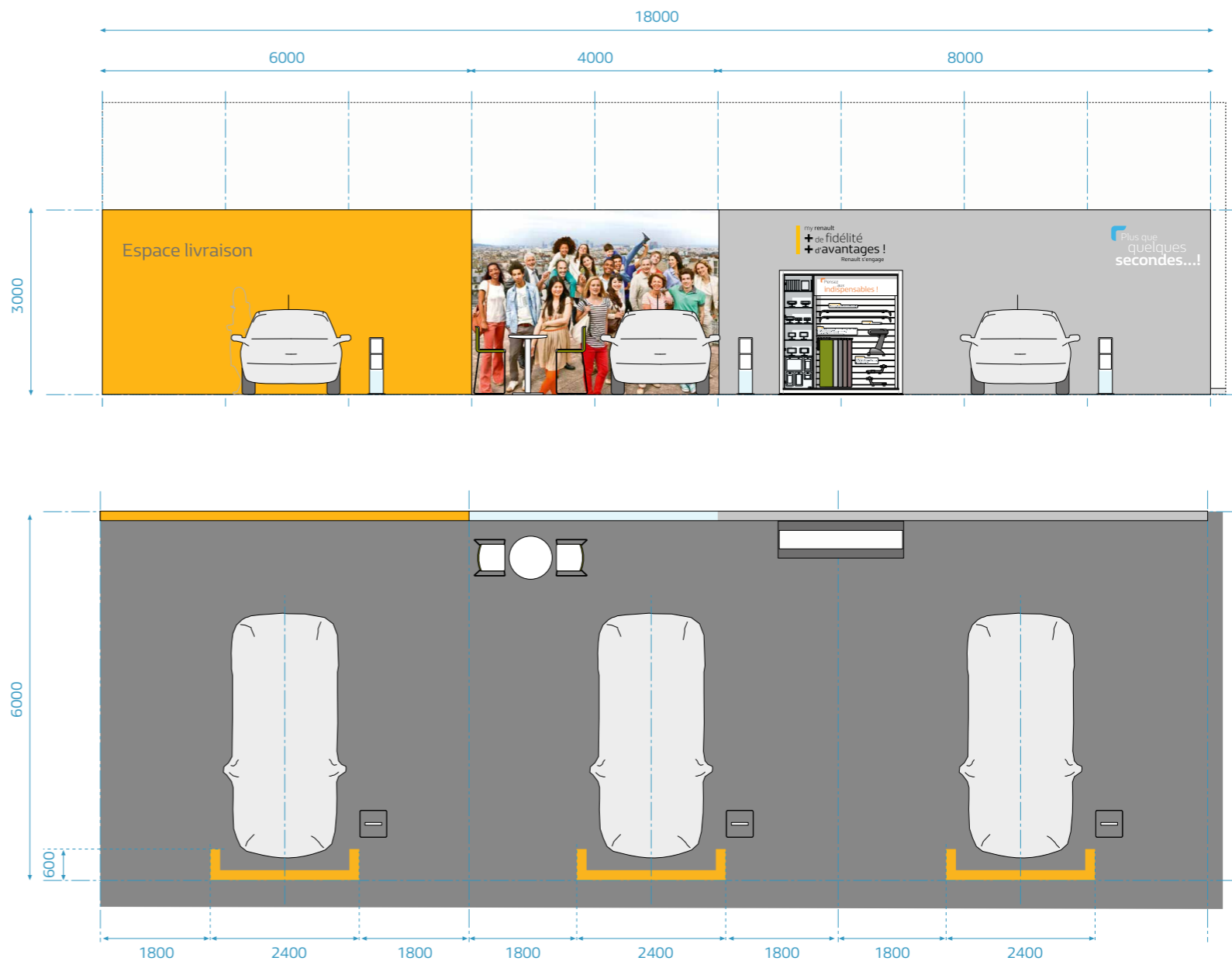

# 18 m configuration with 3 vehicles

## Perpendicular installation of vehicles

### Variant 6

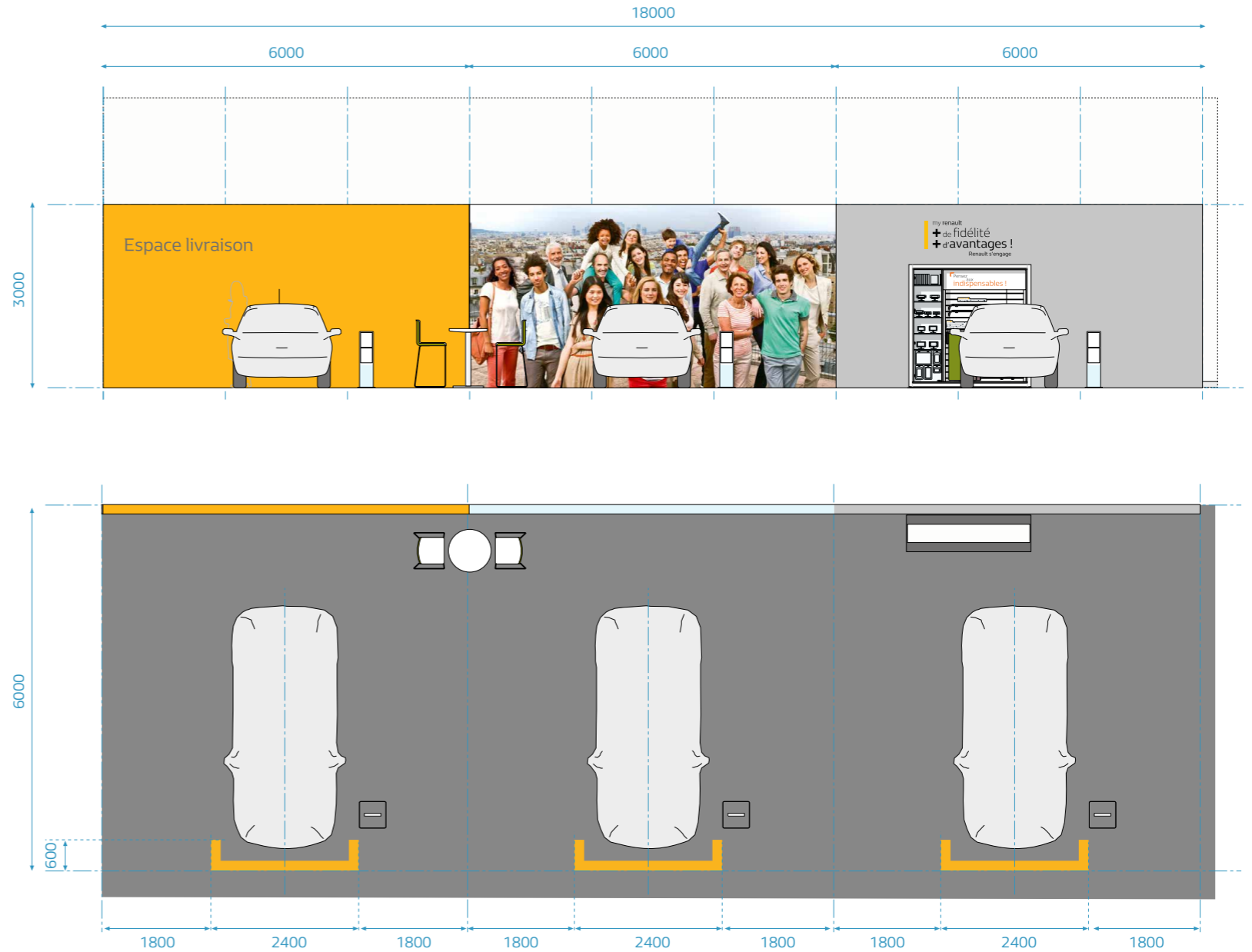

# 18 m configuration with 3 vehicles

## Installation of vehicles at a 45° angle

### Variant 1

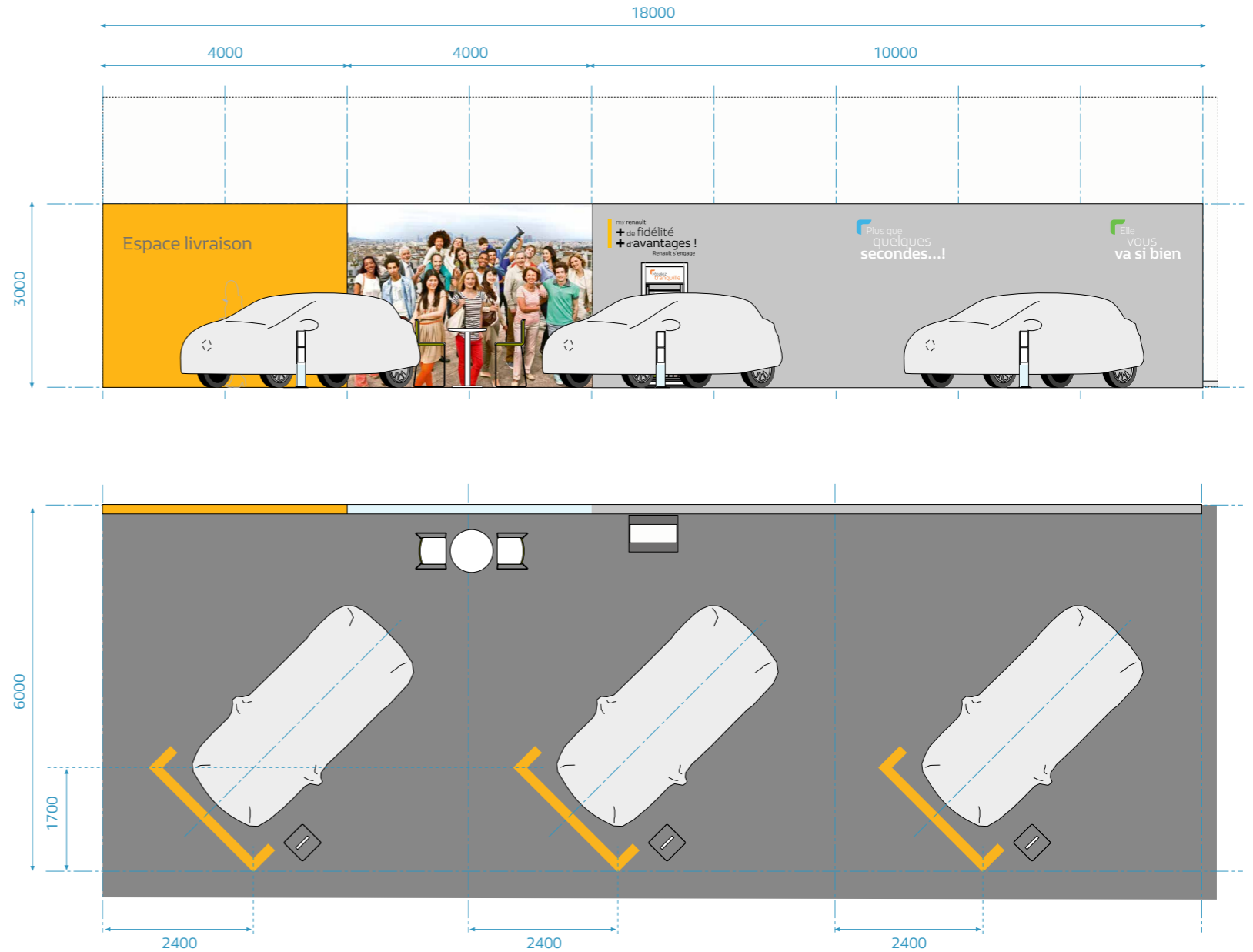

# 18 m configuration with 3 vehicles

## Installation of vehicles at a 45° angle

### Variant 2

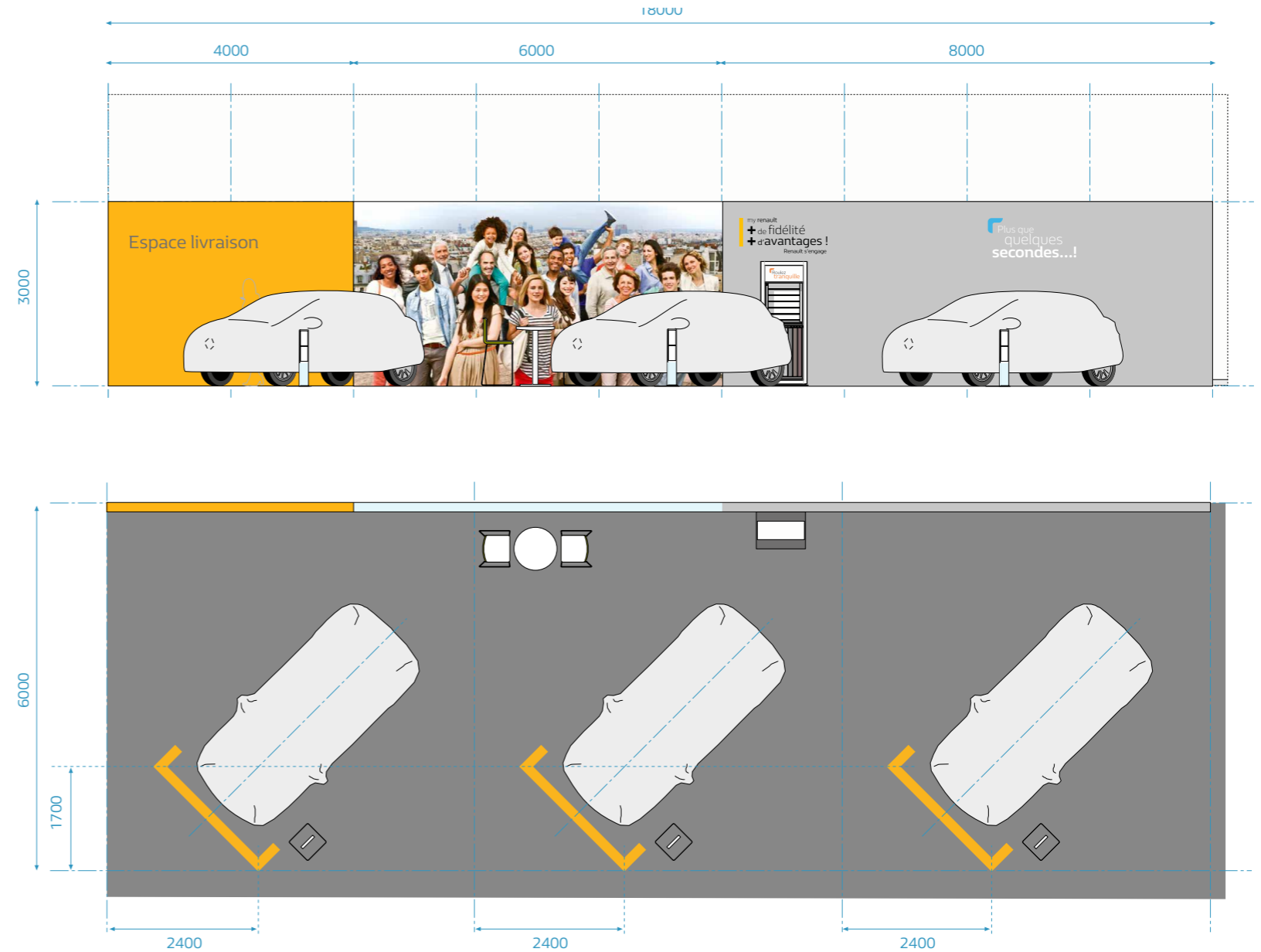

# 18 m configuration with 3 vehicles

## Installation of vehicles at a 45° angle

### Variant 3

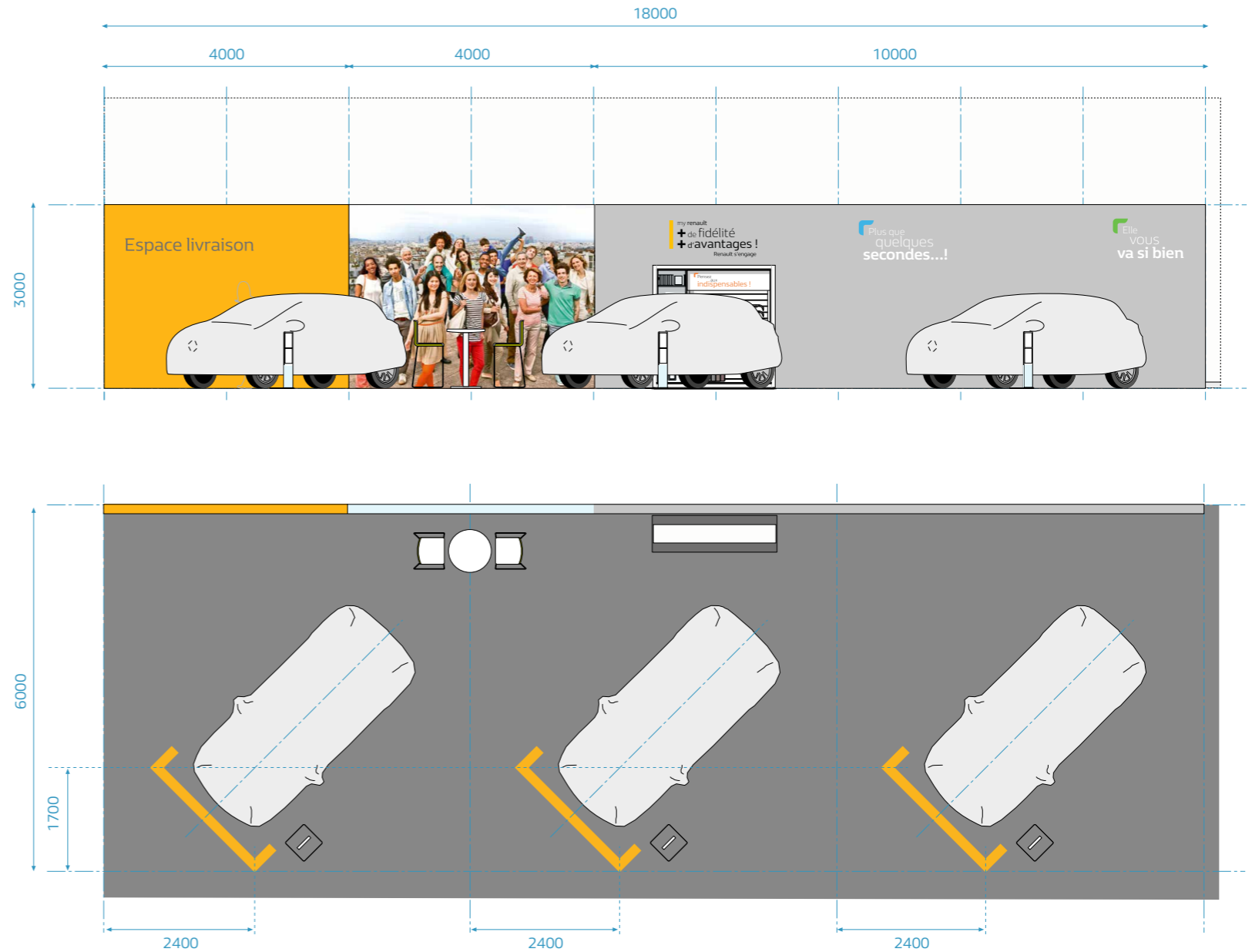

# 18 m configuration with 3 vehicles

## Installation of vehicles at a 45° angle

### Variant 4

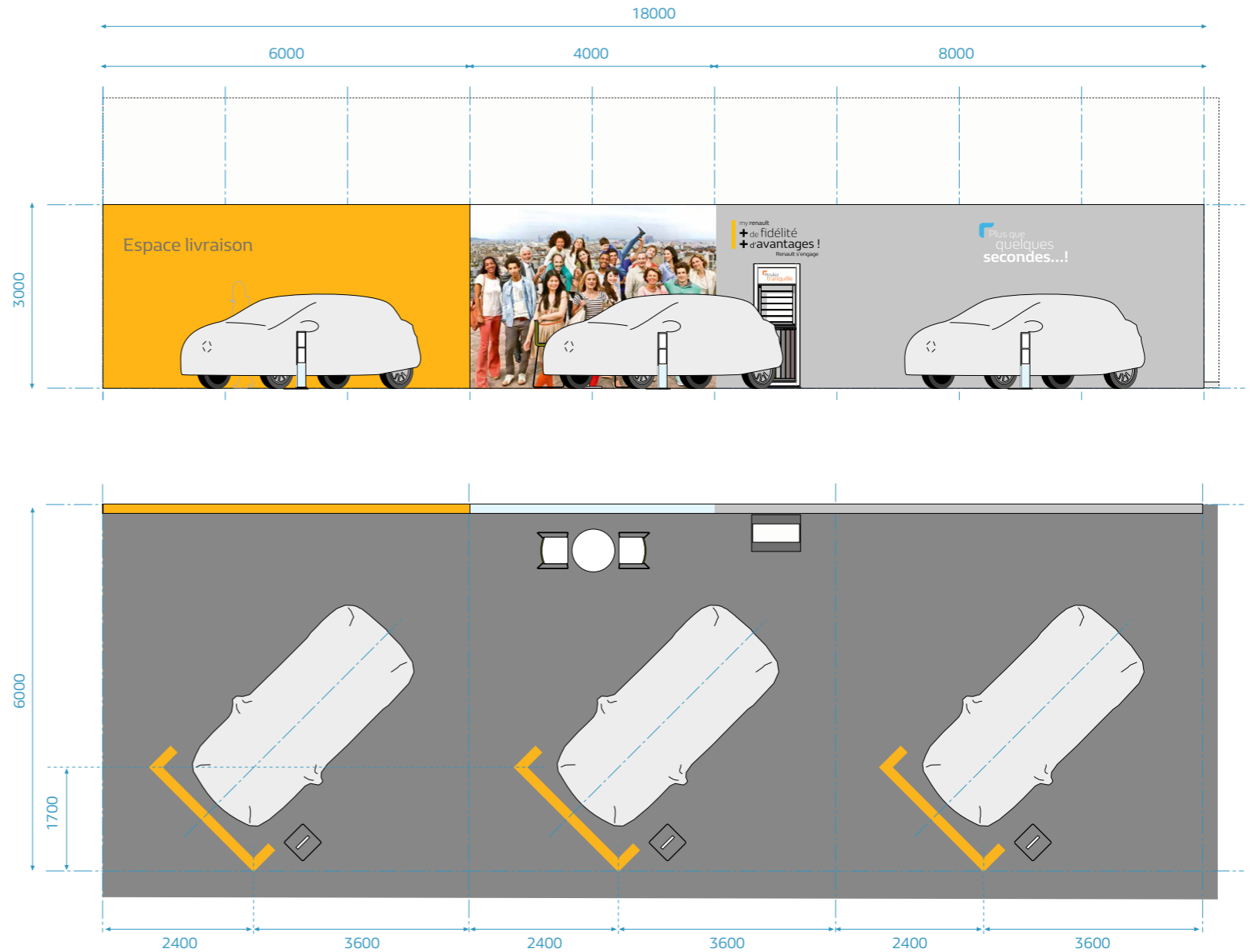

# 18 m configuration with 3 vehicles

## Installation of vehicles at a 45° angle

### Variant 5

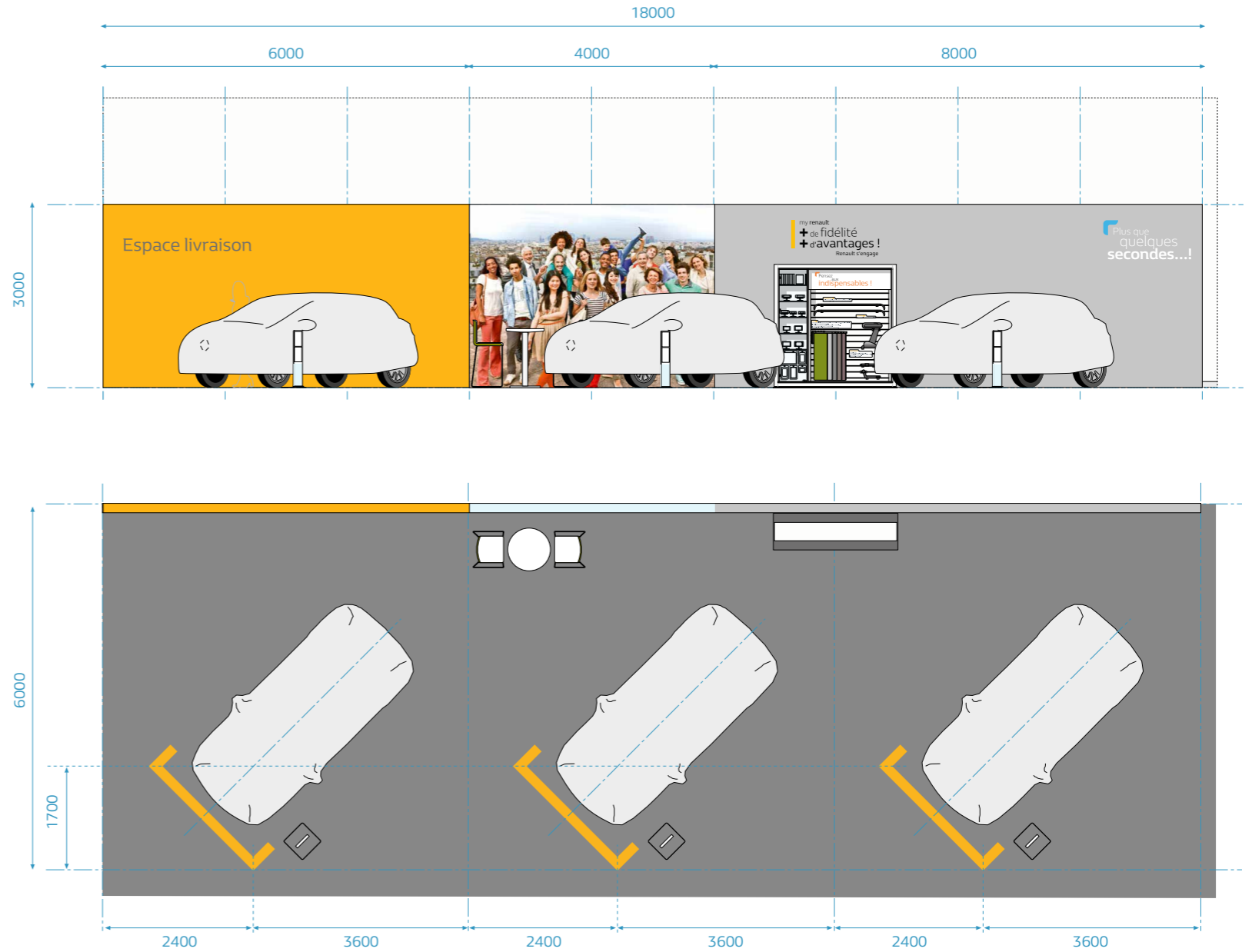



# 18 m configuration with 3 vehicles

## Installation of vehicles at a 45° angle

### Variant 6

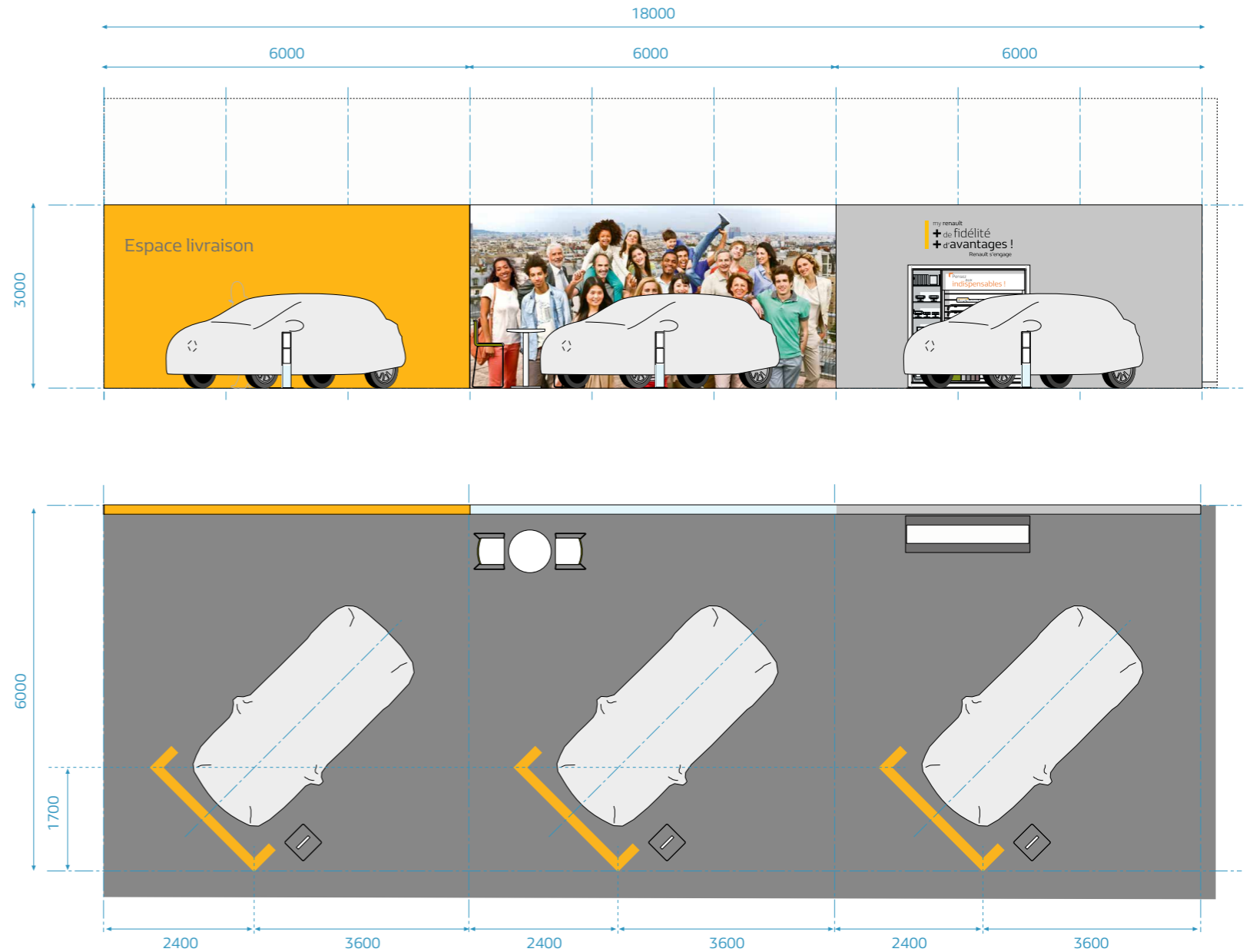

## 20 m configuration for more than 3 vehicles

### In-line installation of vehicles

#### Variant 1

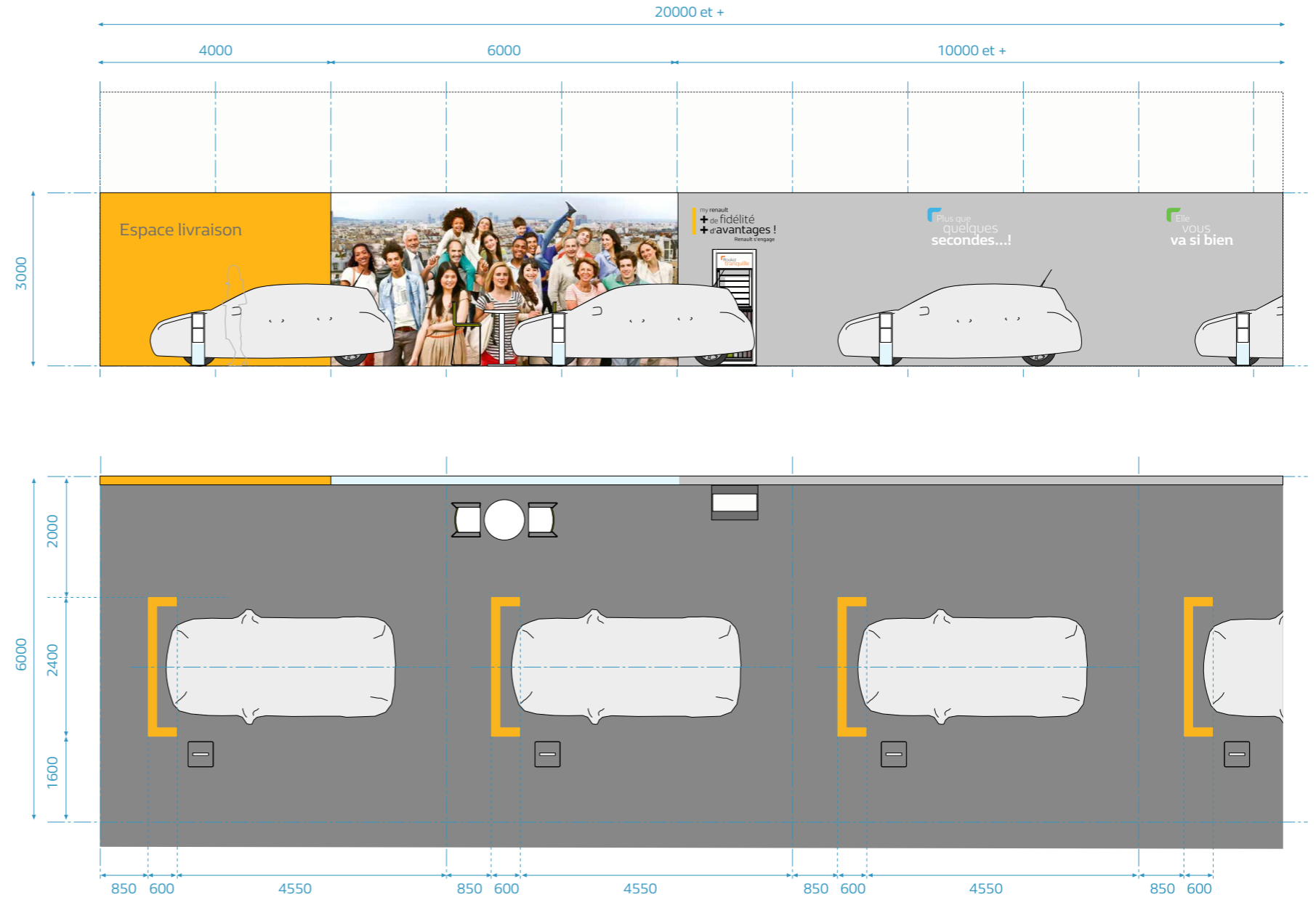

## 20 m configuration for more than 3 vehicles

### In-line installation of vehicles

#### Variant 2

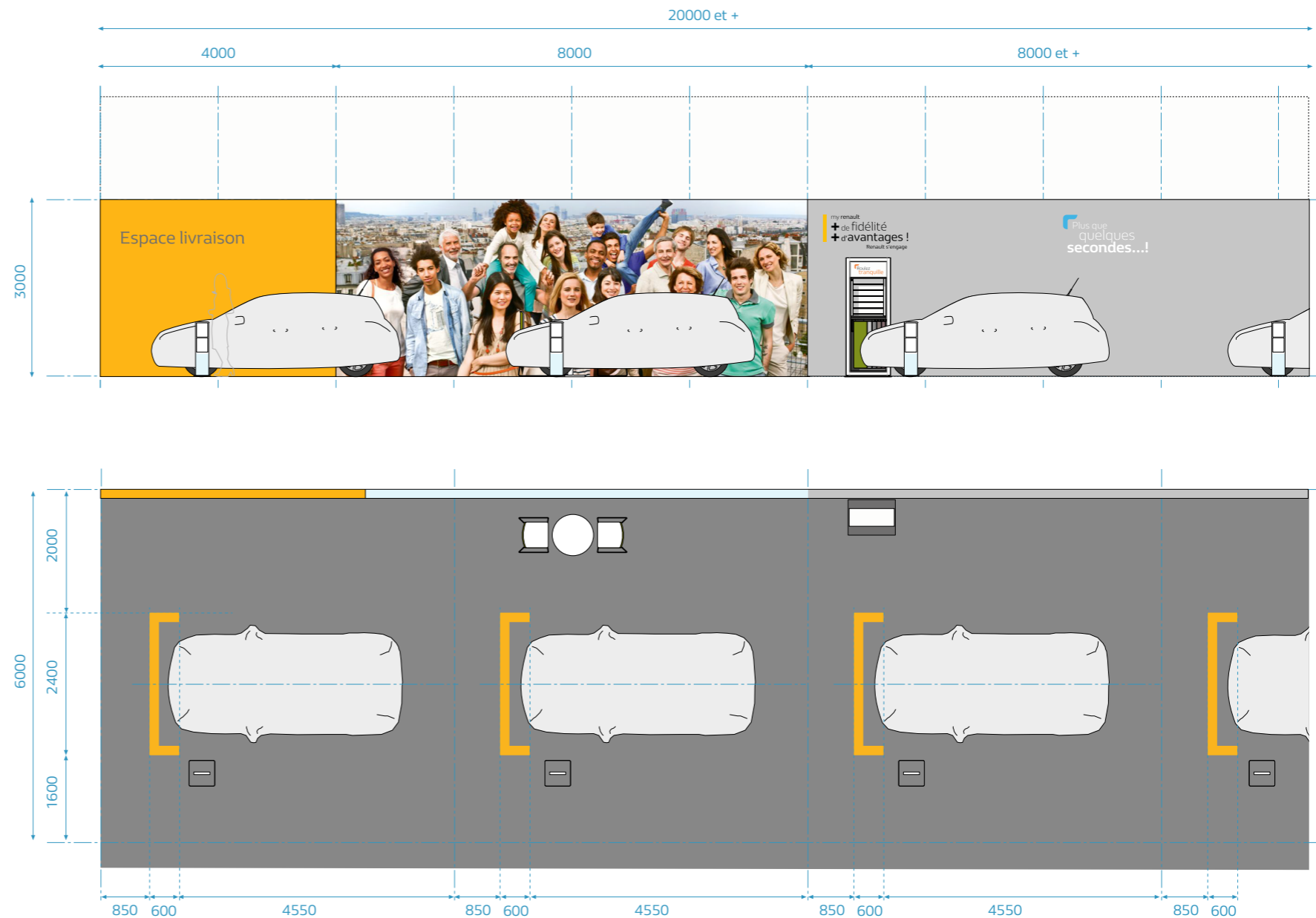

## 20 m configuration for more than 3 vehicles

### In-line installation of vehicles

#### Variant 3

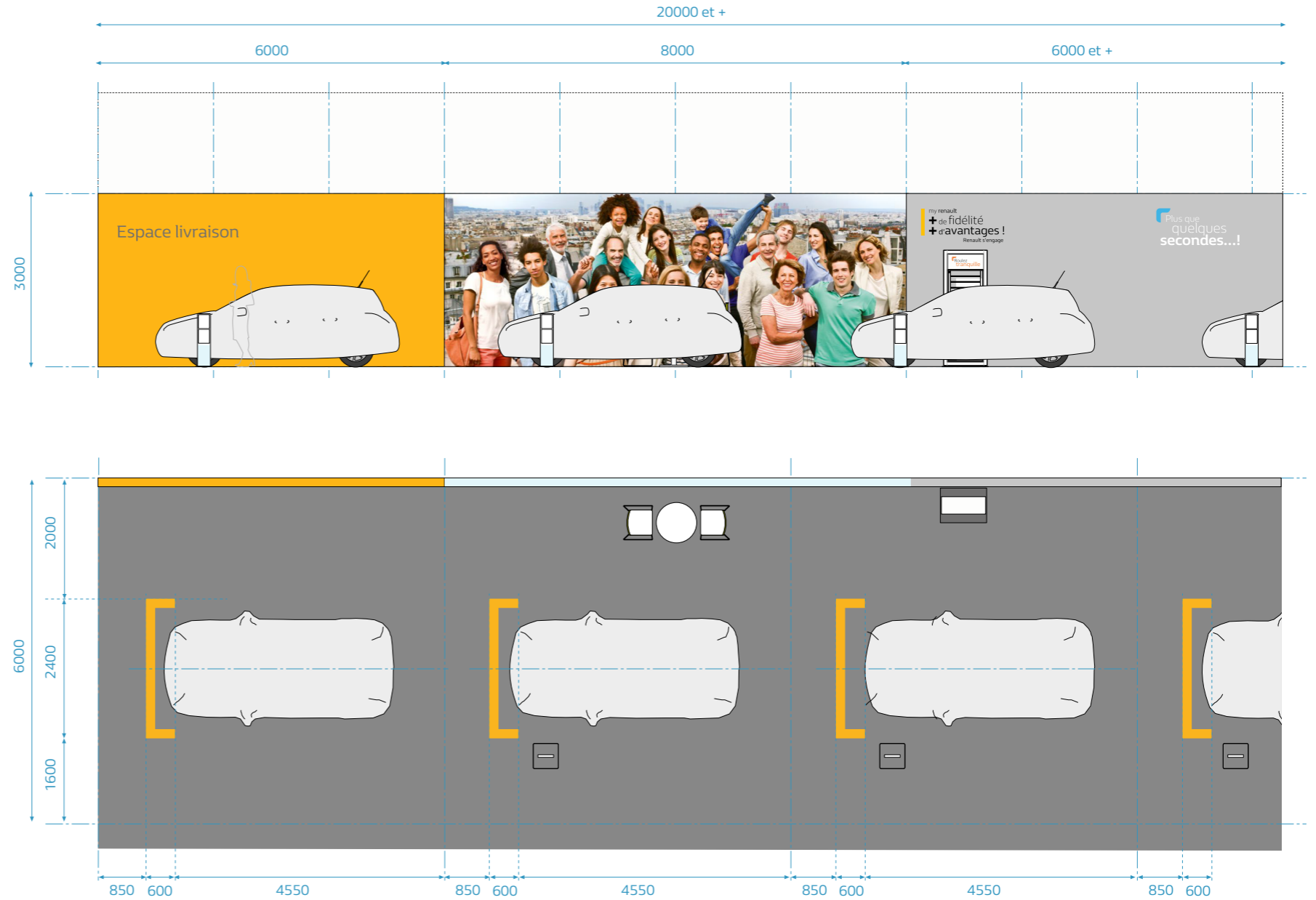

## 20 m configuration for more than 3 vehicles

### Perpendicular installation of vehicles

#### Variant 1

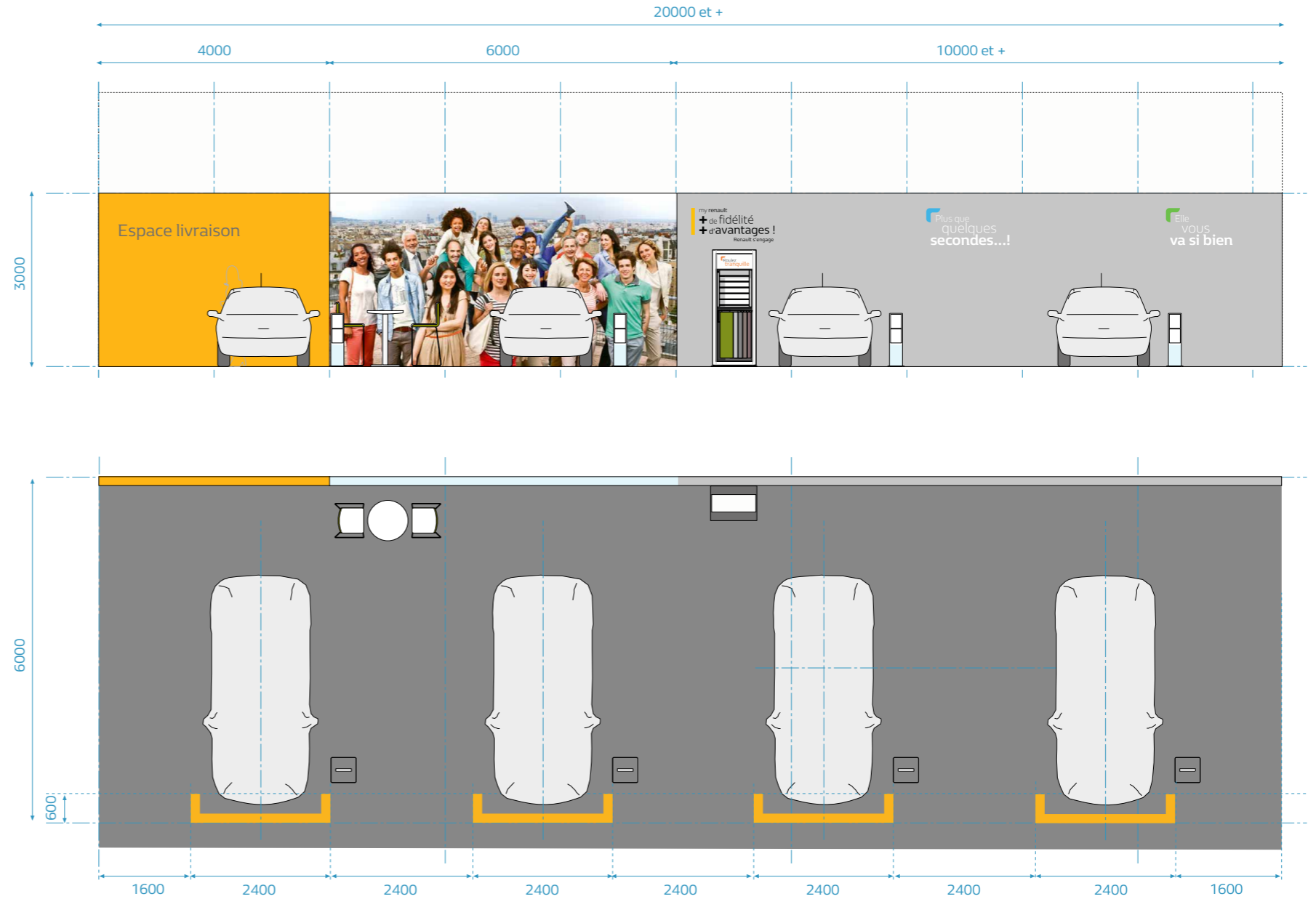

## 20 m configuration for more than 3 vehicles

### Perpendicular installation of vehicles

#### Variant 2

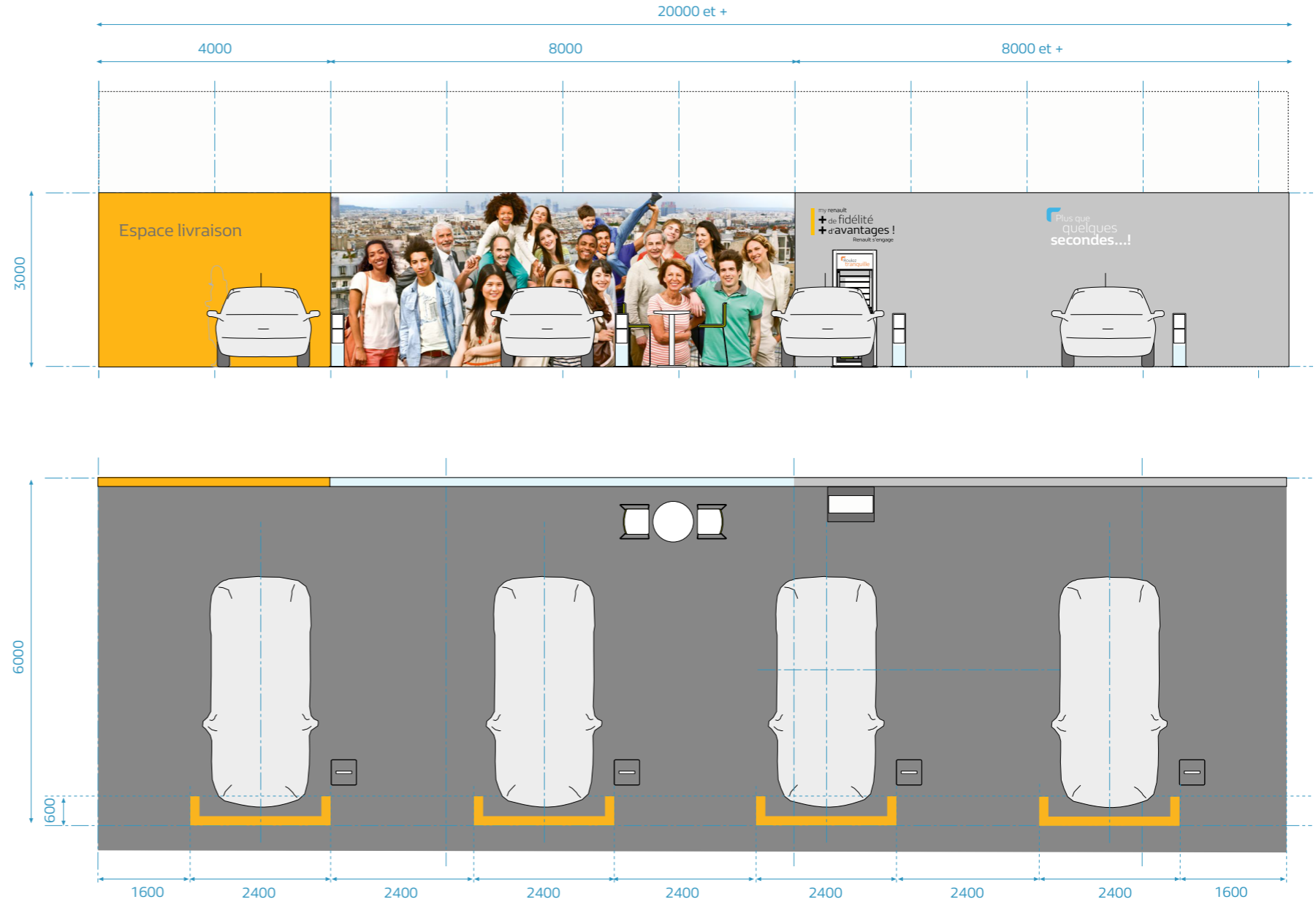

## 20 m configuration for more than 3 vehicles

### Perpendicular installation of vehicles

#### Variant 3

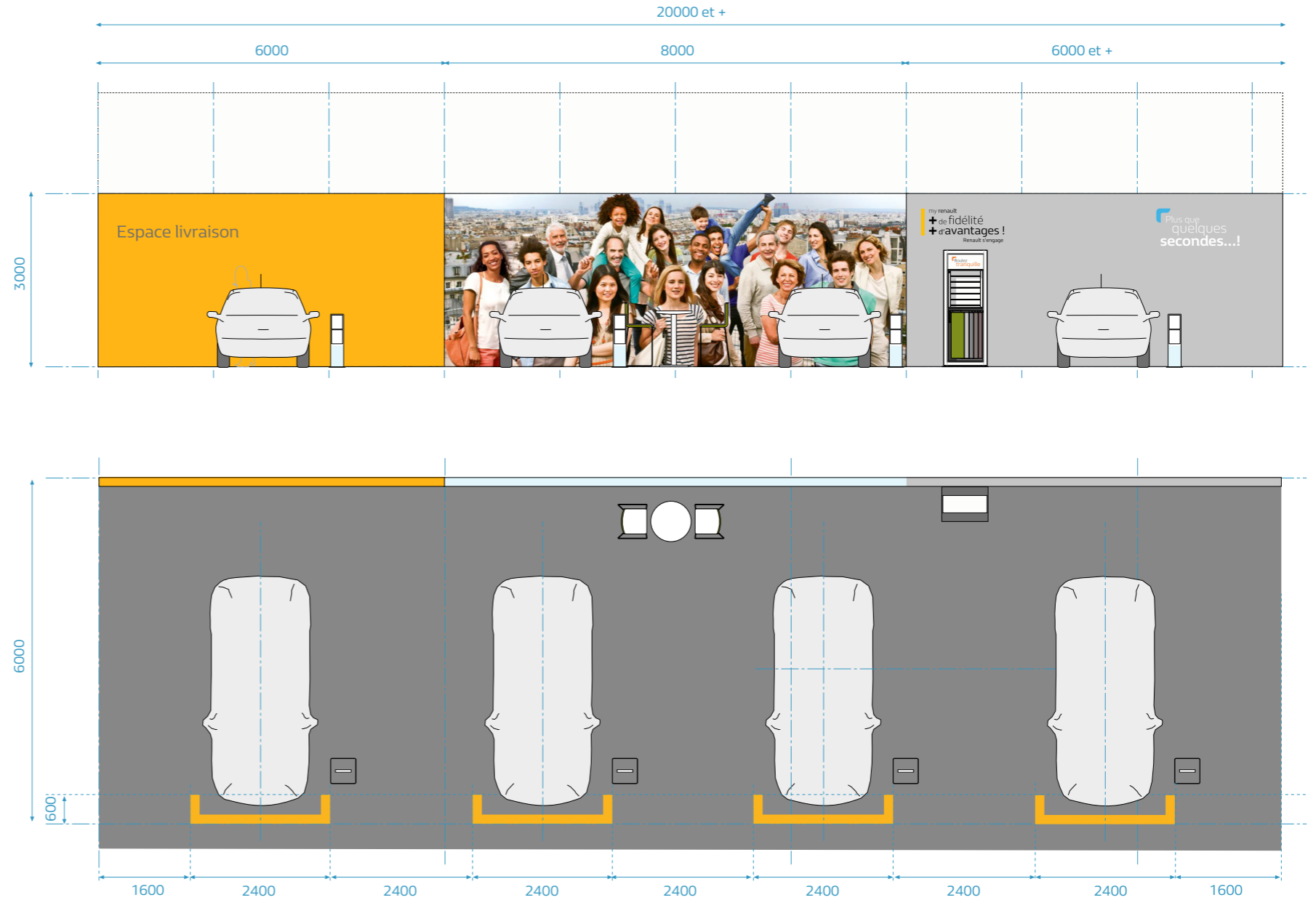

## 20 m configuration for more than 3 vehicles

### Installation of vehicles at a 45° angle

#### Variant 1

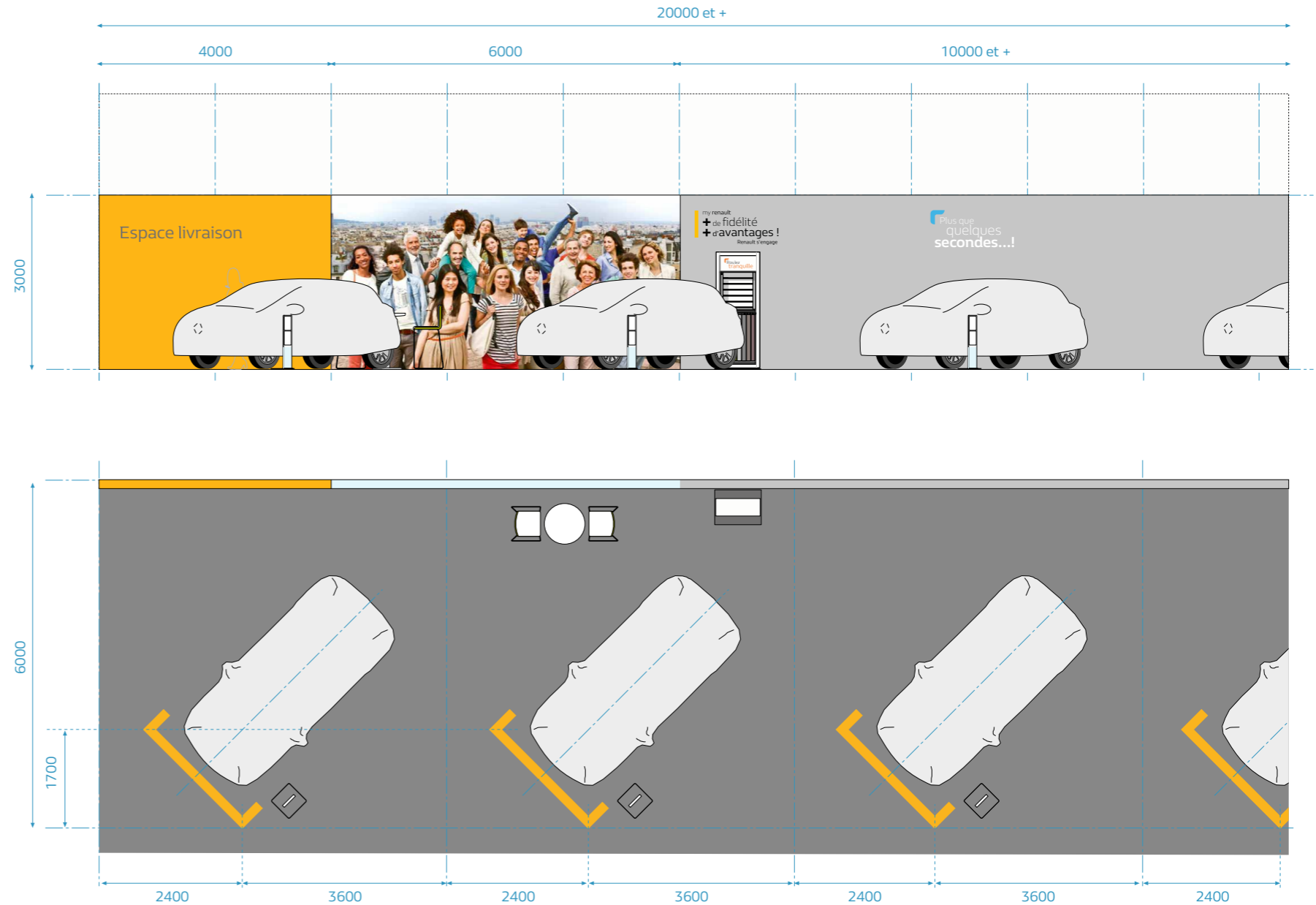



## 20 m configuration for more than 3 vehicles

### Installation of vehicles at a 45° angle

#### Variant 2

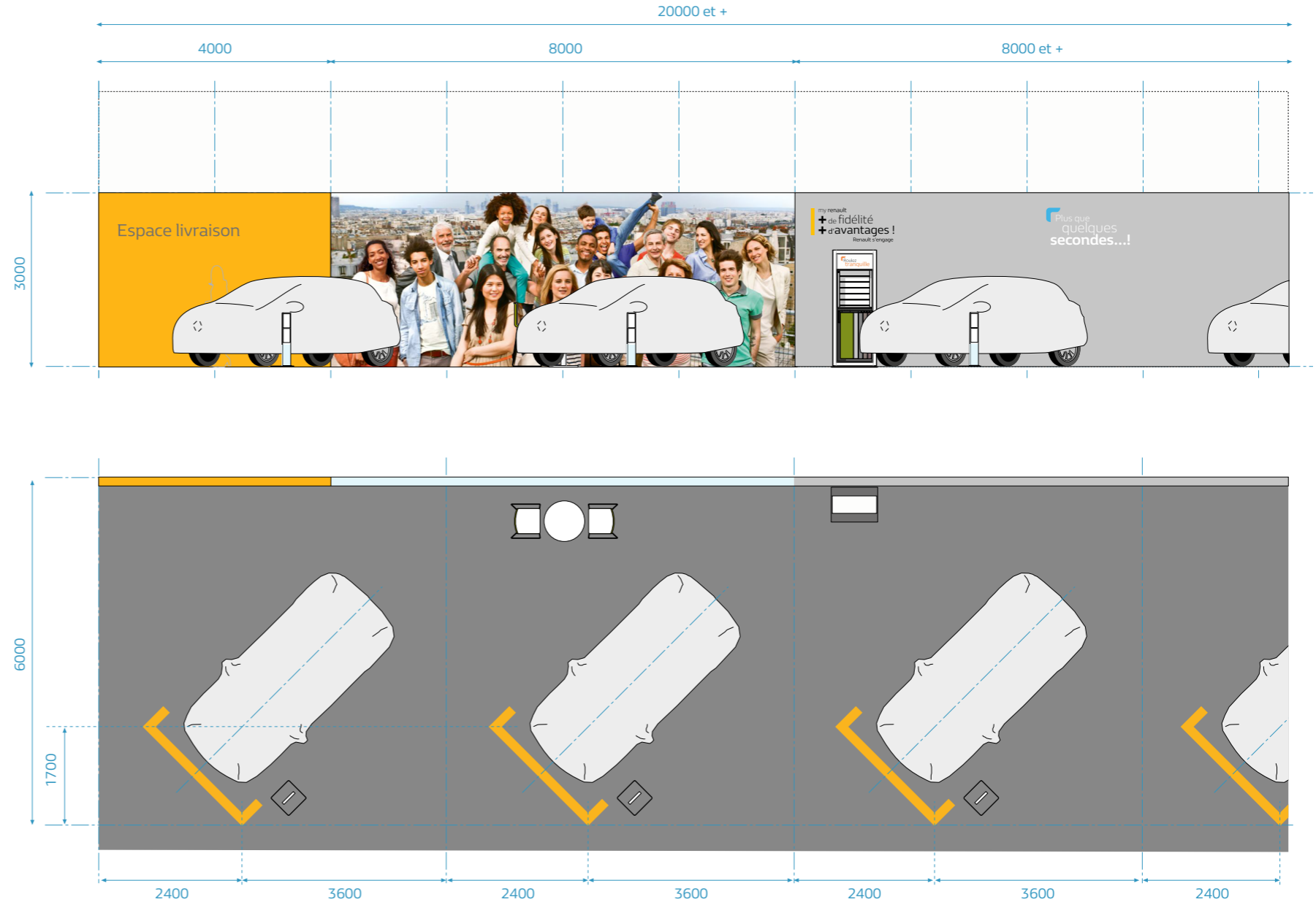

## 20 m configuration for more than 3 vehicles

### Installation of vehicles at a 45° angle

#### Variant 3

